

Fanvil

Fanvil

F52 VoIP Phone User Manual



Corporate Headquarters

Fanvil Technology Co., Ltd

Address: Level 3, Block A, Gaoxinqi Building, Anhua Industrial Park, Qianjin 1 Road, 35th District, Bao'An, Shenzhen, 518101 P.R. China

Web Site: [www. Fanvil.com](http://www.Fanvil.com)

Tel: +86 755 26402199

Fax: +86 755 26402618

Fanvil Technology Co., Ltd

HQ Add: Level 3, Block A, Gaoxinqi Building, Anhua Industrial Park, Qianjin 1 Road, 35th District, Bao'An, Shenzhen, 518101 P.R. China

Tel: +86-755-2640-2199 Fax: +86-755-2640-2618 Email: fanvil@fanvil.com www.fanvil.com Beijing Tel: +86-10-5753-6809
Suzhou Tel: +86-512-6592-0605 SEA Tel: +60-3-203-50737



Safety Notices

Please read the following safety notices before installing or using this phone. They are crucial for the safe and reliable operation of the device.

- Please use the external power supply that is included in the package. Other power supplies may cause damage to the device, affect the behavior or induce noise.
- Before using the external power supply, please be sure it is for use with your power voltage. Incorrect power voltage may cause fire and damage.
- Please do not damage the power cord. If the power cord or plug is damaged, do not use it. This may cause fire or electric shock.
- The power plug should be accessible at all times because this is the only way to remove power from the device.
- Handle the phone carefully. Do not drop it or shake it. Rough handling can cause internal damage.
- Do not install the device in direct sunlight. Also do not put the device on carpets or cushions, or other poorly ventilated locations. This may cause fire or overheating.
- Avoid exposure to temperatures above 40°C, below 0°C or high humidity. Avoid wetting the unit with any liquid.
- Do not use harsh chemicals, cleaning solvents, or strong detergents to clean the device. If cleaning is necessary use a soft cloth that has been slightly dampened in a mild soap and water solution.
- Do not touch the power cord or network cable during a thunderstorm. There is a slight risk of electrical shock.
- Do not attempt to open the device. Consult your authorized dealer for repair.

Table of Contents

1	INTRODUCING F52 VOIP PHONE	- 8 -
1.1	THANK YOU	- 8 -
1.2	BOX CONTENTS	- 8 -
1.3	KEYPAD	- 8 -
1.4	INPUT/OUTPUT PORTS	- 9 -
1.5	ICON INTRODUCTION	- 10 -
1.6	LED INTRODUCTION	- 10 -
1.6.1	Power Indication LED (Power Light Enabled)	- 10 -
1.6.2	Power Indication LED (Power Light Disabled)	- 11 -
2	INITIAL CONNECTION AND SETTING	- 11 -
2.1	CONNECTING THE PHONE	- 11 -
2.2	NETWORK SETTINGS	- 12 -
2.2.1	PPPoE Mode	- 12 -
2.2.2	Static IP Mode	- 13 -
2.2.3	DHCP Mode	- 14 -
3	BASIC FUNCTIONS	- 15 -
3.1	MAKING A CALL	- 15 -
3.1.1	Call Device	- 15 -
3.1.2	Call Methods	- 15 -
3.2	ANSWERING A CALL	- 15 -
3.3	DO NOT DISTURB (DND)	- 15 -
3.4	CALL FORWARD	- 15 -
3.5	CALL HOLD	- 16 -
3.6	CALL WAITING	- 16 -
3.7	CALL TRANSFER	- 16 -
3.7.1	Blind Transfer	- 16 -
3.7.2	Attended Transfer	- 17 -
3.7.3	Semi-Attended Transfer	- 17 -
3.8	3-WAY CONFERENCE CALL	- 17 -
3.9	MULTIPLE-WAY CALL	- 17 -
4	ADVANCED FUNCTIONS	- 17 -
4.1	CALL PICKUP	- 17 -
4.2	JOIN CALL	- 18 -

4.3	REDIAL / UNREDIAL.....	- 18 -
4.4	CLICK TO DIAL.....	- 18 -
4.5	CALL BACK.....	- 19 -
4.6	AUTO ANSWER.....	- 19 -
4.7	HOTLINE/WARMLINE.....	- 19 -
4.8	SPEED DIAL.....	- 19 -
4.9	APPLICATION.....	- 19 -
4.9.1	SMS.....	- 19 -
4.9.2	Memo.....	- 19 -
4.9.3	Voice Mail.....	- 20 -
4.9.4	Ping.....	- 20 -
5	OTHER FUNCTIONS.....	- 20 -
5.1	CALL FORWARD.....	- 20 -
5.2	AUTO ANSWER.....	- 20 -
5.3	AUTO HANDDOWN.....	- 21 -
5.4	CALL WAITING.....	- 21 -
5.5	DND.....	- 21 -
5.6	BAN ANONYMOUS.....	- 21 -
5.7	BAN OUTGOING.....	- 21 -
5.8	HOTLINE.....	- 22 -
5.9	DIAL PLAN.....	- 22 -
5.10	DIAL PEER.....	- 22 -
5.11	INTERCOM.....	- 22 -
5.12	AUTO REDIAL.....	- 22 -
5.13	CALL COMPLETION.....	- 23 -
5.14	POWER LIGHT.....	- 23 -
5.15	HIDE DTMF.....	- 23 -
5.16	PASSWORD DIAL.....	- 23 -
5.17	PRE DIAL.....	- 24 -
5.18	CALL LOGS.....	- 24 -
5.19	DEFAULT LINE.....	- 24 -
5.20	AUTO SWITCH LINE.....	- 24 -
6	BASIC SETTING.....	- 24 -
6.1	KEYBOARD.....	- 24 -
6.2	SCREEN SETTINGS.....	- 25 -
6.3	RING SETTINGS.....	- 25 -

6.3.1	Ring Volume	- 25 -
6.3.2	Ring Type.....	- 25 -
6.4	VOICE VOLUME	- 25 -
6.5	TIME & DATE.....	- 26 -
6.6	GREETING WORDS	- 26 -
6.7	LANGUAGE	- 26 -
7	ADVANCED SETTINGS	- 27 -
7.1	ACCOUNTS.....	- 27 -
7.1.1	Basic Settings.....	- 27 -
7.1.2	Advanced Settings	- 27 -
7.1.3	Service Code.....	- 27 -
7.2	NETWORK.....	- 28 -
7.3	SECURITY	- 28 -
7.4	MAINTENANCE	- 28 -
7.5	FACTORY RESET.....	- 28 -
8	WEB CONFIGURATION.....	- 29 -
8.1	INTRODUCTION OF CONFIGURATION.....	- 29 -
8.1.1	Configuration Methods	- 29 -
8.1.2	Password Configuration.....	- 29 -
8.2	SETTING VIA WEB BROWSER	- 29 -
8.3	CONFIGURATION VIA WEB	- 31 -
8.3.1	BASIC.....	- 31 -
8.3.1.1	Status.....	- 31 -
8.3.1.2	Wizard.....	- 32 -
8.3.1.2.1	Static IP.....	- 33 -
8.3.1.2.2	DHCP.....	- 33 -
8.3.1.2.3	PPPoE	- 33 -
8.3.1.2.4	Quick SIP Settings	- 34 -
8.3.1.3	Call Log	- 35 -
8.3.1.4	Language.....	- 36 -
8.3.2	Network	- 37 -
8.3.2.1	WAN Config	- 37 -
8.3.2.1.1	Static IP.....	- 39 -
8.3.2.1.2	DHCP.....	- 39 -
8.3.2.1.3	PPPoE	- 39 -
8.3.2.2	LAN Config.....	- 40 -

8.3.2.3	Qos & VLAN Config.....	- 41 -
8.3.2.4	Service Port.....	- 44 -
8.3.2.5	DHCP SERVICE.....	- 45 -
8.3.2.6	TIME&DATE	- 46 -
8.3.3	VOIP	- 48 -
8.3.3.1	SIP Configuration	- 48 -
8.3.3.2	IAX2	- 54 -
8.3.3.3	STUN Config.....	- 55 -
8.3.3.4	DIAL PEER	- 57 -
8.3.4	Phone	- 60 -
8.3.4.1	AUDIO	- 60 -
8.3.4.2	FEATURE.....	- 62 -
8.3.4.3	DIAL PLAN.....	- 66 -
8.3.4.4	CONTACT.....	- 67 -
8.3.4.5	REMOTE CONTACT	- 69 -
8.3.4.6	WEB DIAL.....	- 71 -
8.3.4.7	Multicast	- 71 -
8.3.5	Function Key	- 73 -
8.3.5.1	Softkeys	- 73 -
8.3.6	Maintenance.....	- 73 -
8.3.6.1	Auto Provision	- 73 -
8.3.6.2	Syslog	- 77 -
8.3.6.3	Config Setting	- 79 -
8.3.6.4	Update.....	- 80 -
8.3.6.5	Access	- 82 -
8.3.6.6	Reboot.....	- 83 -
8.3.7	Security	- 84 -
8.3.7.1	WEB FILTER	- 84 -
8.3.7.2	Firewall.....	- 85 -
8.3.7.3	Network Address Translation (NAT)	- 86 -
8.3.7.4	VPN	- 89 -
8.3.7.5	Security.....	- 90 -
8.3.8	Logout.....	- 91 -
9	APPENDIX.....	- 91 -
9.1	SPECIFICATION.....	- 91 -
9.1.1	Hardware.....	- 91 -
9.1.2	Voice Features	- 92 -

9.1.3	Network Features.....	- 94 -
9.1.4	Maintenance and management.....	- 95 -
9.2	DIGIT-CHARACTER MAP TABLE	- 96 -

1 Introducing F52 VoIP Phone

1.1 Thank you

Thank you for purchasing the F52 Voice Over Internet Protocol (VoIP) telephone. The F52 is a fully featured telephone that provides voice communication over the data network. This phone has all the features of a traditional telephone and all gives access to many data service features. This guide will help you easily use the various features and services available on your phone.

1.2 Box Contents





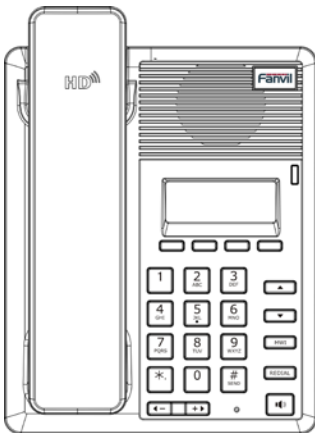

The following items should be packed with your telephone. Please contact your dealer if any of them are missing.

- Telephone (Main body) with display and keypad
- Handset
- Handset cord
- Power supply
- Ethernet cable







1.3 Keypad











Key	Key name	Function Description
-----	----------	----------------------

	Navigation	These keys are used in many areas of phone operation. Depending on the application they will have different functions.
	Redial	When off hook, this will dial the last called number. In stand-by mode, it will check the Outgoing Call.
	Volume +/-	Adjust the volume by pressing these two keys.
	Speaker	Activate speakerphone mode.
	Indicator light	This light blinks to indicate a missed call.
	Soft key 1/2/3/4	Various functions depending on the phone mode. Description will be shown in LCD.
	Keyboard	Dial phone numbers

1.4 Input/Output Ports

Port	Port name	Description
	Power switch	Input: 5V AC, 1A
	WAN	10/100M Connect it to Network
	LAN	10/100M Connect it to PC
	Handset	Port type: RJ-9 connector

1.5 Icon Introduction

Icon	Description
	Call out
	Call in
	Call hold
	Auto answer
	Contact
	DND(Do not Disturb)
	In hand free mode
	In handset mode
	SMS
	Missed call
	Call forward

1.6 LED Introduction

1.6.1 Power Indication LED (Power Light Enabled)

LED Status	Description
Steady red	Power on.
Blinking red	There is an incoming call.
Off	Power off.

1.6.2 Power Indication LED (Power Light Disabled)

LED Status	Description
Blinking red	There is an incoming call

2 Initial Connection and Setting

2.1 Connecting the phone

1. Connect to the network. Use the Ethernet cable in the package to connect the WAN port on the back of your phone to an Ethernet port. The following 3 figures show connection options.
 - a. Shared network connection—This method requires at least one available Ethernet port. Connect the WAN port on the back of your phone to the Ethernet port. Since the phone has a built-in router, it can be connected directly to the network.
 - b. Direct network connection—Use this method if you have a single Ethernet port which is already in use. Disconnect the Ethernet cable from the Ethernet port and attach it to the WAN port on the back of the phone. Then use the Ethernet cable in the package to connect the LAN port on the back of the phone to the other device. The IP Phone now shares a network connection.
 - c. Access by router connection—Connect one end of the network cable to the F52’s WAN port the other end is connected to your broadband router’s LAN port, so that the completion of the network hardware connections. In most cases, you must configure your network settings to DHCP mode.

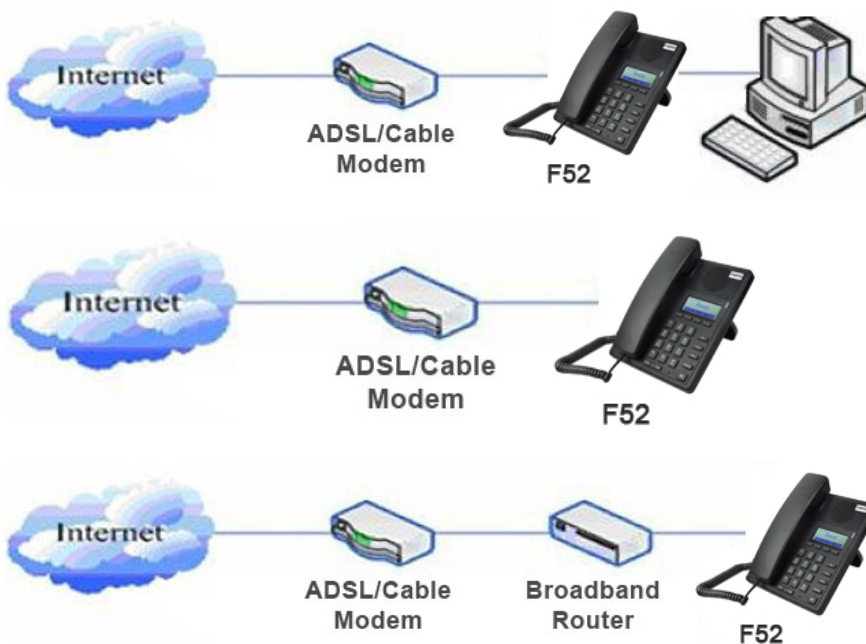

2. Connect the handset to the handset jack using the handset cable in the package.
3. Connect the power supply to the DC port on the back of the phone. Connect the power supply to a standard power outlet. Note that the power supply will not be needed if your network provides Power over Ethernet (PoE).
4. The phone's LCD screen displays "INITIALIZING". Later, a ready screen displays the date, time and current network mode.

If your LCD screen displays different information from the above, more information may need to be entered. Please refer to the next section. If your phone registers into your IP telephony Server, it is ready to use. If not, continue to read for more configuration information.

2.2 Network Settings

DHCP is supported by default. This allows the phone to receive an IP address and other network-related settings (Netmask, IP gateway, DNS server) from the DHCP server. If no DHCP server is available, the network connection settings must be changed. Follow the instructions below to change to either PPPoE or static IP.

2.2.1 PPPoE Mode

1. Press the Menu softkey.
2. Scroll down to "3 Settings."
3. Press Enter.
4. Scroll down to "2 Advanced Settings."
5. Press Enter.
6. The LCD will display "Enter Password".
7. Input the password (default value is 123).
8. Press Enter.
9. Scroll down to "2 Network."
10. Press Enter.
11. Press Enter to select WAN Settings.
12. Scroll down to "4 PPPoE Settings."
13. Press Enter.
14. Use the keypad to enter the User Name.
15. Press Save.
16. Press Down key.
17. Use the keypad to enter the Password.

18. Press Save.
19. Press Down key.
20. Use vol-/vol+ key to enable PPPoE.
21. Press Save.
22. Press Back to return to the WAN Settings screen.
23. Press up/down key to scroll to “1 Connection Mode.”
24. Press Enter.
25. Use vol-/vol+ to select “PPPoE.”
26. Press Save.
27. Press Back times to return to idle screen.
28. Disconnect and reconnect the power supply so the phone will reboot and apply the new settings.

2.2.2 Static IP Mode

1. Press the Menu softkey.
 1. Scroll down to “3 Settings.”
 2. Press Enter.
 3. Scroll down to “2 Advanced Settings.”
 4. Press Enter.
 5. The LCD will display “Enter Password”.
 6. Input the password (default value is 123).
 7. Press ENTER.
 8. Scroll down to “2 Network.”
 9. Press Enter.
 10. Press Enter to select WAN Settings.
 11. Scroll down to “2 Static IP Settings.”
 12. Press Enter.
 13. Use the keypad to enter the IP Address.
 14. Press Save softkey.
 15. Press Down key.
 16. Use the keypad to enter the Subnet Mask.
 17. Press Save softkey.
 18. Press Down key.
 19. Use the keypad to enter the Gateway Address.
 20. Press Save softkey.
 21. Press Down key.
 22. Use the keypad to enter the DNS 1 Address.
 23. Press Save softkey.

24. Press Down key.
25. Use the keypad to enter the DNS 2 Address if desired.
26. Press Save softkey.
27. Press Back softkey.
28. Press up/down key to scroll to “1 Connection Mode.”
29. Press Enter.
30. Use vol-/vol+ to select “Static IP.”
31. Press Save softkey.
32. Press Back or Exit 6 times to return to idle screen.
33. Disconnect and reconnect the power supply so the phone will reboot and apply the new settings.

2.2.3 DHCP Mode



1. Press the Menu softkey.
2. Scroll down to “3 Settings.”
3. Press Enter.
4. Scroll down to “2 Advanced Settings.”
5. Press Enter.
6. The LCD will display “Enter Password”.
7. Input the password (default value is 123).
8. Press Enter.
9. Scroll down to “2 Network.”
10. Press Enter.
11. Press Enter to select WAN Settings.
12. Scroll down to “3 DHCP Settings.”
13. Press Enter.
14. Use vol-/vol+ to enable or disable DHCP DNS.
15. Press Save softkey.
16. Press Down key.
17. Use vol-/vol+ to enable or disable DHCP Time.
18. Press Save softkey.
19. Press Back softkey.
20. Press up/down key to scroll to “1 Connection Mode.”
21. Press Enter.
22. Use vol-/vol+ to select “DHCP.”
23. Press Save softkey.
24. Press Back or Exit 6 times to return to idle screen.
25. Disconnect and reconnect the power supply so the phone will reboot and apply the new settings.

3 Basic Functions

3.1 Making a call

3.1.1 Call Device

Calls can be made using two different devices:

1. Handset - Pick up the handset. The  icon will be shown on the LCD screen.
 34. Speakerphone - Press the Speaker button. The  icon will be shown on the LCD screen.
- The number may also be dialed first. Then the method of speaking can be chosen.

3.1.2 Call Methods

Use one of the following methods to place a call.

1. Dial the desired number using the keypad.
2. Press the REDIAL button to redial the last number called.
3. Press the Dial softkey to make the call if necessary.

3.2 Answering a call

If the phone is idle, lift the handset, press the Speaker button or Answer softkey to answer Using the speaker phone to answer.

If the phone is in use, press the Answer softkey.

During the conversation, you can alternate between Handset and Speaker phone by pressing the corresponding buttons or picking up the handset.

3.3 Do Not Disturb (DND)

Press the DND softkey then use vol-/vol+ to select Phone,Line,Disabled to active or disabled DND Mode.

If you select Phone ,New incoming calls will be rejected and the display will show:  icon.

If you select Line,you should press Down key then select Line1 or Line2 to Enable ,after new incoming calls will be rejected and the display will show:  icon.

If you select Disabled,Incoming calls will be ring and stored in the Call History.

3.4 Call Forward

This feature allows forwarding an incoming call to another phone number. The display shows  icon.

The following call forwarding events can be configured:

Off: Call forwarding is deactivated by default.

Always: Incoming calls are immediately forwarded.

Busy: Incoming calls are immediately forwarded when the phone is busy.

No Answer: Incoming calls are forwarded when the phone is not answered after a specific period.

To configure Call Forward via Phone interface:

1. Press Menu ->Features->Enter>Call Forward->Enter.
2. Select the line to be forwarded.
3. Use vol-/vol+ to select Disabled, Always, Busy, or No Answer.
4. After choosing a mode (except Disabled), press Down key and then enter the phone number for forwarding.
5. Press Save to save the changes.

3.5 Call Hold

1. Press the Hold softkey to put the active call on hold.
35. If there is only one call on hold, press the Hold softkey to retrieve the call.
36. If there is more than one call on hold, press the Up/Down key to highlight the call, then press the Resume button to retrieve the call.

3.6 Call Waiting

1. Press Menu ->Features->Enter->Call Waiting->Enter.
37. Use the navigation keys to activate or deactivate call waiting.
38. Press Save to save the changes.

3.7 Call transfer

3.7.1 Blind Transfer

During a conversation, press the XFER key, dial the number to which the call is to be transferred followed by "#" and then hang up.

3.7.2 Attended Transfer

During a conversation, press the XFER key, dial the number to which the call is to be transferred followed by "#" and press Send. After the third party answers, press XFER to complete the transfer.

NOTE: Call waiting and call transfer must be enabled.

NOTE: The SIP server must support RFC3515.

3.7.3 Semi-Attended Transfer

During a conversation, press the XFER key, dial the number to which the call is to be transferred. Then press the Send softkey. When the third party phone begins to ring, press XFER to complete the transfer.

NOTE: Call waiting and call transfer must be enabled.

3.8 3-way conference call

1. Press the Conf softkey during an active call.
39. The first call will be placed on hold and dial tone will be heard.
40. Dial the number to be added to the conference.
41. Press Dial.
42. When the call is answered, press Conf to add the caller to the conference.
43. To release the conference, press Split.

3.9 Multiple-way call

To add a fifth party to four active calls

1. Press Conf softkey or XFER softkey
2. Press OK
3. Enter the number
4. Press Dial and wait for the other party to answer.
5. Use the arrow keys to select a call.

4 Advanced Functions

4.1 Call pickup

This allows a third party to answer a call by dialing a code. For example: A calls B, but there is no answer. C can go off hook, dial a code plus B's number, and pick up the call.

The following chart shows how to configure this in the dial peer screen.

Number	Destination	Port	Mode	Alias	Suffix	Deleted Length
*1*T	0.0.0.0	5060	SIP	rep:pickup	no suffix	3

1 is the code. After saving the above configuration, C can dial *1* plus B's phone number to pick up A's call. The prefix can be set to anything the user desires that does not interfere with other dialing rules.

4.2 Join call

This allows a third party to join an existing call. For example: If B and C are on a call, A can join by dialing a code plus the number for B or C. This assumes that B or C also support Join Call.

The following chart shows how to configure this in the dial peer screen.

Number	Destination	Port	Mode	Alias	Suffix	Deleted Length
*2*T	0.0.0.0	5060	SIP	rep:joincall	no suffix	3

2 is the code. After saving the above configuration, A can dial *2* plus the number for B or C to join B and C's call. The prefix can be set to anything the user desires that does not interfere with other dialing rules.

4.3 Redial / Unredial

If B is on a call when A calls, A will get busy tone. If A wants to connect to B as soon as B is available, he can use the redial function. To use this feature, A dials a prefix and then B's number.

When the redial function is activated, A will check B's calling status every 60 seconds. When B is available, A's phone will ring. When A goes off hook, the phone will call B automatically. If A does not want to call B, the redial function can be cancelled by dialing a prefix plus B's number.

Number	Destination	Port	Mode	Alias	Suffix	Deleted Length
*3*T	0.0.0.0	5060	SIP	rep:redial	no suffix	3
*4*T	0.0.0.0	5060	SIP	rep:unredial	no suffix	3

3 is the redial prefix code. A can dial *3* plus B's phone number to activate the redial function.

4 is the unredial prefix code. A can dial *4* to cancel the redial function.

The user can select any prefix as long as it does not interfere with dialing rules.

4.4 Click to dial

If User A browses to User B's phone number or SIP address in the contact page and clicks it, User A's phone will ring. After he goes off hook, the phone will call User B.

Note: This feature requires that the software on PC or PBX support click to dial.

4.5 Call back

This function will redial the last received call.

4.6 Auto answer

If this feature is activated, the phone will answer incoming calls after a programmable delay.

4.7 Hotline/Warmline

This feature will cause the phone to place a call to a programmed number whenever it goes off-hook. A different hotline number can be set for each SIP line.

4.8 Speed dial

This feature will allow you make speed dial easily. If you set up speed dial with name and tel numbers for 1~9, and then you can dial n# to make the corresponding speed dial number directly.

4.9 Application

4.9.1 SMS

1. Press + ->Applications->Enter->SMS->Enter.
2. Use the navigation keys to highlight the options. Messages can be read in the Inbox/Outbox.
3. Press Reply to reply to a message. Use the 2aB softkey to change the Input Method. After entering the reply, press OK, use the navigation keys to select the line from which you want to send, then press Send.
4. To write a new message, press New. Use the 2aB softkey to change the Input Method. After entering the reply, press OK, use the navigation keys to select the line from which you want to send, and press Send.
5. To delete a message, press Del. You have three options to choose: Yes, All, No.

4.9.2 Memo

Memos can be recorded in the phone as reminders.

Press Menu->Application->Memo->Enter->Add.

Options for Mode, Date, Time, and Ring Tone can then be configured. The reminder text can also be entered. When the configuration is completed, press Save.

4.9.3 Voice Mail

1. Press Menu->Application->Voice Mail->Enter.
2. Use the navigation keys to highlight the line for which you want to set voicemail.
3. Press Edit
4. Use the navigation keys to enable voicemail.
5. Input the number. Press 2aB softkey if necessary to change the input method.
6. Press Save to save the change.
7. To hear a new voicemail, press the Voicemail softkey. Then press Dial. It may then be necessary to enter a password.

4.9.4 Ping

1. Press Menu->Application->Ping->Enter.
2. Enter the IP Address to be pinged.
3. Press Start
4. Display will show “Ping IP Address”
5. After approximately 5 seconds, the display will show “OK” if the ping is successful or “Failed” if the ping is unsuccessful.

5 Other Functions

5.1 Call Forward

If this feature is enabled, the phone will forward to another phone.

6. Press Menu ->Features-> Enter->Auto Answer-> Enter.
7. Use Up/Down key to select line.
8. Use vol-/vol+ to Enable.
9. Use Up/Down key to access number setting.

5.2 Auto Answer

If this feature is enabled, the phone will answer a ringing line after a specified time.

1. Press Menu ->Features-> Enter->Auto Answer-> Enter.
2. Use Up/Down key to select line.
3. Use vol-/vol+ to Enable.
4. Use Up/Down key to access time setting.

5. Use keypad to enter time in seconds.

5.3 Auto Handdown

This is the time after a call ends before the phone returns to the idle state.

1. Press Menu ->Features-> Enter->Auto Handdown-> Enter.
2. Use vol-/vol+ to Enable.
3. Use Up/Down key to access time setting.
4. Use keypad to enter time in minutes.

5.4 Call Waiting

If you turn off call waiting, when there is a second way you can not call all the way incoming.

1. Press Menu ->Features-> Enter->Call Waiting-> Enter.
2. Use vol-/vol+ to Enable.
3. Use Up/Down key to access tone setting.

5.5 DND

If this function is enabled the new incoming calls will be rejected.

1. Press Menu ->Features-> Enter->DND-> Enter.
2. Use vol-/vol+ to Enable.
3. Use Up/Down key to access line setting.
4. Use vol-/vol+ to Enable.

5.6 Ban Anonymous

If this function is enabled, the phone will block calls with no Caller ID information.

1. Press Menu ->Features-> Enter->Ban Anonymous Call-> Enter.
2. Choose the SIP Account from which to Ban Anonymous Call.
3. Press OK
4. Use vol-/vol+ to Enable.

5.7 Ban Outgoing

If this function is enabled, the phone cannot make outgoing calls.

Press Menu ->Features-> Ban Outgoing-> Enter.

5.8 Hotline

If you turn on automatically as you set the number of call setup time.

1. Press Menu ->Features-> Enter->Hotline-> Enter.
2. Use Up/Down key to select line.
3. Use vol-/vol+ to Enable.
4. Use Up/Down key to access time setting.
5. Use Up/Down key to access number setting.

5.9 Dial Plan

1. Press Menu ->Features-> Enter->Dial Plan-> Enter.
2. The following items in the dial plan can be enabled or disabled: Press # to Send, Timeout to Send, Timeout, Fixed Length Number, Press # to Do BXFER, BXFER On Onhook, AXFER On Onhook.

Note: It is recommended that Dial Plan be configured from the web interface.

5.10 Dial Peer

1. Press Menu ->Features-> Enter->Dial Peer-> Enter.
2. Select Add to enter the Edit interface, and input information.

Note: It is recommended that Dial Peer be configured from the web interface. Refer to Section 8.3.3.4.

5.11 Intercom

Enables/Disables Intercom calls

Press Menu ->Features-> Enter->Intercom-> Enter.

5.12 Auto Redial

If Auto Redial is enabled, the phone will continue to retry a busy call. The user sets the retry interval and the number of times to redial. The user is also given the option to activate this feature on each busy call.

1. Press Menu ->Features-> Enter->Auto Redial-> Enter.
2. Use vol-/vol+ to Enable.
3. Use Up/Down key to select Interval and Times.
4. Press Save.

5.13 Call completion

This is similar to Auto Redial except that it detects the state of the called number before making a new call attempt.

1. Press Menu ->Features-> Enter->Call Completion-> Enter.
2. Use vol-/vol+ to Enable.
3. Press Save.

5.14 Power Light

This feature enables the power light at the bottom of the phone.

Press Menu ->Features-> Enter->Power LED-> Enter.

5.15 Hide DTMF

This feature sets how DTMF digits are displayed after a call is in progress. For example, dial a PIN code to access banking information.

1. Press Menu ->Features-> Enter->Hide DTMF-> Enter.
2. Use vol-/vol+ to select one of the following 4 choices.
 - a) Disabled – All the digits will be shown on the LCD.
 - b) All – None of the digits will be shown on the LCD. The “*” will be shown.
 - c) Delay – The last digit entered will be shown for a short time and then replaced by “*.”
 - d) Last Show – The last digit entered will be shown. Previous digits are replaced by “*.”

5.16 Password Dial

This feature controls the display of dialed digits. When enabled, a password and length can be set.

Example: A call is placed to 6625551212. Password is set to 662 and length is set to 3. Display will show 662***1212.

1. Press Menu ->Features-> Enter->Passwd Dial-> Enter.
2. Use vol-/vol+ to enable the feature.
3. Use Up/Down key to move to Prefix.
4. Use keypad to enter prefix.
5. Use Up/Down key to move to Length.
6. Use keypad to enter Length.
7. Use BACK or EXIT to return to idle screen.

5.17 Pre Dial

If this feature is enabled, digits dialed on-hook will be transmitted when the phone goes off-hook
Press Menu ->Features-> Pre Dial-> Enter.

5.18 Call Logs

If this feature is disabled,you will not see the call logs.

1. Press Menu ->Features-> Enter->Call Logs-> Enter.
2. Use vol-/vol+ to enable.

5.19 Default Line

If this feature is disabled, The handset displays Greeting Words.

1. Press Menu ->Features-> Enter->Call Logs-> Enter.
2. Use vol-/vol+ to enable.

5.20 Auto Switch Line

If this feature is enabled,then the opportunity to use the first available line call path.

1. Press Menu ->Features-> Enter->Auto Switch Line-> Enter.
2. Use vol-/vol+ to enable.

6 Basic Setting

6.1 Keyboard

1. Press Menu ->Settings-> Enter->Basic Settings-> Enter->Keyboard->Enter.
2. There are four sets of keys which can be configured.
 - a) DSS Keys – Keys on the right side of the phone beside the Speakerphone button or Line Keys.
 - b) Programmable Keys – Arrow keys and OK key
 - c) Desktop Long Pressed – Action to take when Programmable Key is pressed and held.
 - d) Soft Key – Keys under the display
3. Use Up/Down key and Enter to select the key.
4. Use vol-/vol+to select the function.
5. Press OK to save.
6. Use BACK or EXIT to return to idle screen.

6.2 Screen Settings

1. Press Menu ->Settings-> Enter->Basic Settings-> Enter->Screen Settings->Enter.
2. The following items can be set.
 - a) Contrast – Set the contrast of the LCD.
 - b) Contrast Calibration – Set the level of contrast that the current contrast setting provides.
 - c) Backlight – Enable or disable LCD backlight.
3. Press OK to save.
4. Use BACK or EXIT to return to idle screen.

6.3 Ring Settings

6.3.1 Ring Volume

1. Press Menu ->Settings-> Enter->Basic Settings-> Enter->Ring Settings->Enter->Ring Volume->Enter.
2. Use vol-/vol+ to select the desired ring volume from the 9 choices. The phone will ring at the selected volume shortly after it is selected.
3. Press Save.
4. Use BACK or EXIT to return to idle screen.

6.3.2 Ring Type

1. Press Menu ->Settings-> Enter->Basic Settings-> Enter->Ring Settings->Enter->Ring Type->Enter.
2. Use vol-/vol+ to select the desired ring type. There are 9 standard types and 3 user types. The user type can be configured from the web interface. The phone will ring at the selected type shortly after it is selected.
3. Press Save.
4. Use BACK or EXIT to return to idle screen.

6.4 Voice Volume

1. Press Menu ->Settings-> Enter->Basic Setting-> Enter->Voice Volume->Enter.
2. Use vol-/vol+ to select the desired voice volume from the 9 choices.
3. Press Save.
4. Use BACK or EXIT to return to idle screen.

6.5 Time & Date

1. Press Menu ->Settings->Enter->Basic Settings-> Enter->Time & Date->Enter.
2. Use vol-/vol+ to choose Auto or Manual. If Auto is chosen, the phone will get date and time information from a time server. The IP address of this server may need to be entered. If Manual is chosen, the date and time must be entered.
3. Use Up/Down key to move to the following items. Use vol-/vol+ to make selection.
 - a) SNTP Server – Time Server IP address – This is the only item that must be configured if auto is chosen.
 - b) Time Zone – This is shown as an offset from GMT.
 - c) Format – Date Display format.
 - d) Type – Character used as delimiter in date display.
 - e) 12 Hour Clock – If disabled, clock is 24 hour.
 - f) Daylight Saving Time
4. Press Save.
5. Use BACK or EXIT to return to idle screen.

6.6 Greeting Words

This feature shows the words displayed in the upper left of the LCD. Default is VOIP PHONE.

1. Press Menu ->Settings-> Enter->Basic Settings-> Enter->Greeting Word->Enter.
2. Enter the message using the keypad. It may be necessary to change the input mode using the soft keys. Use DELETE to remove characters and 0 for space. Maximum message length is 12 characters.
3. Press Save.
4. Use BACK or EXIT to return to idle screen.

6.7 Language

1. Press Menu ->Settings-> Enter->Basic Settings-> Enter->Language Set ->Enter.
2. Use vol-/vol+ to choose English or Chinese.
3. Press Save.
4. Use BACK or EXIT to return to idle screen.

7 Advanced Settings

7.1 Accounts

This allows configuration of SIP account parameters. After selecting one of the three available accounts, the following items may be configured.

7.1.1 Basic Settings

1. Display Name – Name send in Caller ID
2. Outbound Proxy - SIP Outbound Proxy IP Address
3. Registration – Enable or disable registration for this account.
4. Server Address – SIP Server IP Address
5. Server Port – SIP Port – Default 5060
6. SIP User – SIP User name
7. Auth User – User name for authentication
8. Auth Password – Password for authentication

7.1.2 Advanced Settings

1. Domain Realm – SIP Domain
2. Dial Without Registered – Enable or disable dialing with no SIP registration
3. Anonymous – Privacy Support. Choose RFC3323, RFC3325 or None
4. DTMF Mode – Choose RFC2833, SIP_Info, In-band, or Auto
5. Use STUN – Enable or disable use of STUN Server. If enabled, the IP address of the STUN server must be entered.
6. Local Port – Local SIP Port – Default 5060
7. Ring Type – Select ring type for this account. See Section 6.3.2.
8. MWI Number – Number for Message Waiting
9. Pickup Number – Code for call pickup
10. Park Number – Code for call park
11. Join Call Number – Code to join a call
12. Missed Call Logs – Enable or disable

7.1.3 Service Code

Sets the codes to be dialed to an IP PBX to enable or disable the following functions.

1. Mode – Selects whether or not all these codes are active.
2. DND
3. Always CFW – Always Call Forward
4. Busy CFW - Call Forward Busy
5. No Answer CFW - Call Forward No Answer
6. Anonymous

7.2 Network

Enter Network settings as discussed in Section 2.2.

7.3 Security

1. Menu Password – Password to enter configuration menu.
2. Keyboard Password – If this feature is enabled, this password must be entered whenever the keypad is used.
3. Keyboard Status – Enable or disable key lock as described above.

7.4 Maintenance

See Section 8.3.6 for a detailed explanation of each option. It is recommended that these features be accessed through the web interface.

4. Auto Provision – Select DHCP Option, Plug and Play, or Phone Flash for autoprovision.
5. TR069 – Enable or disable configuration via TR069.
6. Backup – Select Config, Phonebook or none for backup. File name must be entered.
7. Upgrade – Select Image, MMI Set, BMF, Ring, Config, or Phonebook for upgrade. File name must be entered.

7.5 Factory Reset

Choose Yes to return the phone to factory default settings.

8 Web Configuration

8.1 Introduction of configuration

8.1.1 Configuration Methods

There are three methods which can be used to configure this phone:

1. Phone keypad – As discussed in previous sections
2. Web browser - Recommended way
3. Telnet with CLI command

8.1.2 Password Configuration

There are two levels of access: root level and general level. A user with root level access can browse and set all configuration parameters, while a user with general level can set all configuration parameters except server parameters for SIP or IAX2.

- Default user with general level:
 - Username: guest
 - Password: guest
- Default user with root level:
 - Username: admin
 - Password: admin

The default password for the phone screen menu is 123.

8.2 Setting via web browser

Enter the phone's IP address into the address bar of the web browser. This assumes that the pc and the phone are on the same subnet. Note: Internet Explorer, Firefox, Chrome, or Safari are supported browsers.

If the IP address is not known, it can be displayed on the phone's LCD by pressing the Menu->Status.

After entering the IP address, the following screen is displayed.

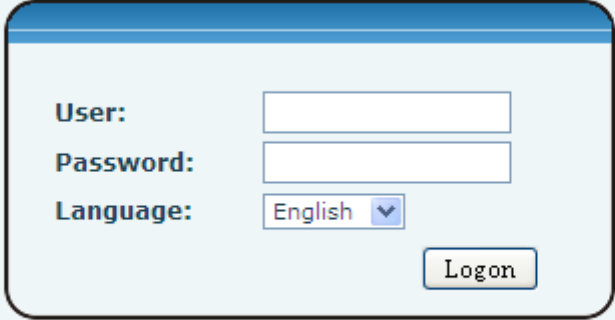

The image shows a login form with the following fields and controls:

- User:** A text input field.
- Password:** A text input field.
- Language:** A dropdown menu currently set to "English".
- Logon:** A button to submit the login information.

After configuring the IP phone, remember to click SAVE under the Maintenance tab. If this is not done, the phone will lose the modifications when it is rebooted.

8.3 Configuration via WEB

8.3.1 BASIC

8.3.1.1 Status

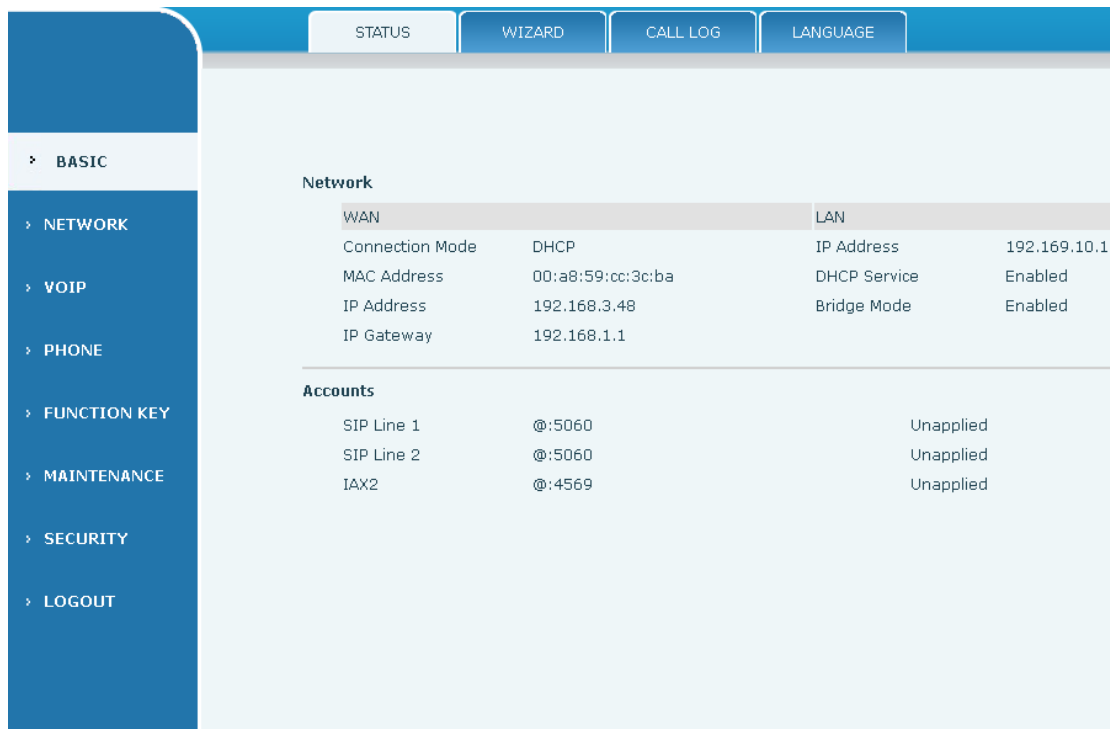

Network	
WAN	LAN
Connection Mode	DHCP
MAC Address	00:a8:59:cc:3c:ba
IP Address	192.168.3.48
IP Gateway	192.168.1.1

Accounts	
SIP Line 1	@:5060 Unapplied
SIP Line 2	@:5060 Unapplied
IAX2	@:4569 Unapplied

Field Name	Explanation
Network	Shows the configuration information for WAN and LAN port, including connection mode of WAN port (Static, DHCP, PPPoE), MAC address, IP address of WAN port and LAN port, DHCP server status for LAN port (ENABLED or DISABLED).
Accounts	Shows the phone numbers and registration status for the 2 SIP LINES and 1 IAX2 server.

8.3.1.2 Wizard

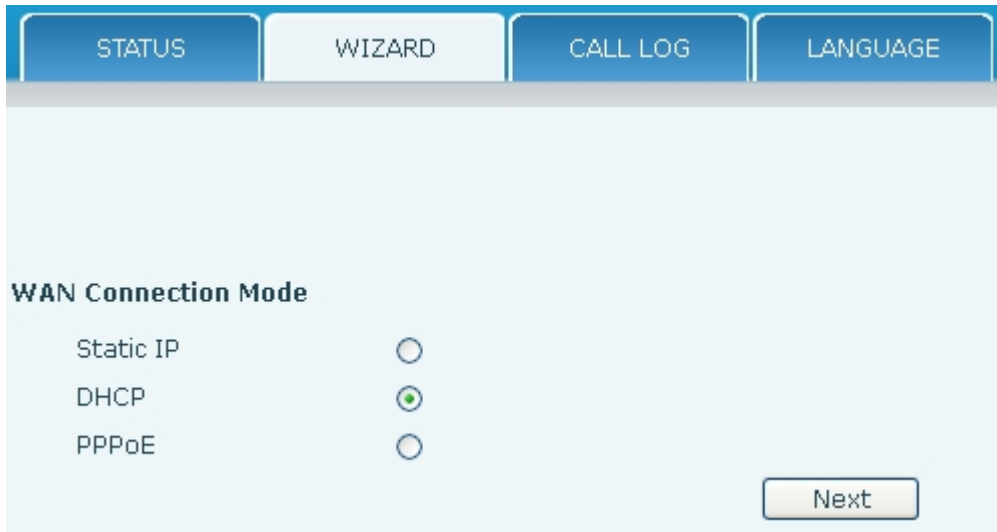

The screenshot shows a web interface with a navigation bar at the top containing four tabs: STATUS, WIZARD, CALL LOG, and LANGUAGE. The WIZARD tab is active. Below the navigation bar, the main content area is titled "WAN Connection Mode". Under this title, there are three radio button options: "Static IP", "DHCP", and "PPPoE". The "DHCP" option is selected, indicated by a green dot in the center of its radio button. To the right of the radio buttons, there is a "Next" button.

Select the appropriate network mode. The phone supports three network modes:

- 1 Static: The parameters of a Static IP connection must be provided by your ISP.
- 2 DHCP: In this mode, network parameter information will be obtained automatically from a DHCP server.
- 3 PPPoE: In this mode, you must enter your ADSL account and password.

Refer to Section 2.2 for detailed information about configuring the network parameters.

8.3.1.2.1 Static IP

If Static IP is selected, this screen will be displayed. Information provided by the ISP should be entered.

Field	Value
IP Address	192.168.1.179
Subnet Mask	255.255.255.0
IP Gateway	192.168.1.1
DNS Domain	
Primary DNS	202.96.134.133
Secondary DNS	202.96.128.68

Click Back to return to the Wizard screen. Click Next to go to Quick SIP Settings

8.3.1.2.2 DHCP

After selecting DHCP and clicking NEXT, the Quick SIP Settings screen will appear. Click Back to return to the Wizard screen. Click Next to go to the Summary screen.

8.3.1.2.3 PPPoE

If PPPoE is selected, this screen will appear. Enter the information provided by the ISP.

Field	Value
Service Name	ANY
User	user123
Password

Click Back to return to the Wizard screen. Click Next to go to Quick SIP Setting.

8.3.1.2.4 Quick SIP Settings

Field Name	Explanation
Display Name	The name shown in caller ID.
Server Address	SIP server address either IP address or URI.
Server Port	SIP server port (usually 5060).
Authentication User	Login name or Authentication ID.
Authentication Password	SIP password.
SIP User	Phone number.
Enable Registration	Submits registration information. Normally checked.

Click Back to return to the IP Address screen. Click Next to see summary screen.

The screenshot shows a configuration wizard with four tabs: STATUS, WIZARD, CALL LOG, and LANGUAGE. The WIZARD tab is active. The WAN section is configured with the following values:

Field	Value
Connection Mode	PPPoE
Service Name	ANY
User	user123

The SIP section is configured with the following values:

Field	Value
Server Address	
Account	
Phone Number	
Registration	Disabled

At the bottom of the SIP section, there are two buttons: "Back" and "Finish".

Click Finish button to save settings and reboot. After the reboot, SIP calls can be made.

8.3.1.3 Call Log

Outgoing call logs can be seen on this page.

The screenshot shows the same configuration wizard with the CALL LOG tab selected. The page displays "Call Information" with a table header:

Start Time	Duration	Dialed Calls
------------	----------	--------------

Field Name	Explanation
Start Time	Start time of the outgoing call
Duration	Duration of the outgoing call.
Dialed Calls	Account, protocol, and line of the outgoing call.

8.3.1.4 Language

The screenshot shows the 'LANGUAGE' configuration page in the Fanvil web interface. At the top, there is a navigation bar with four tabs: 'STATUS', 'WIZARD', 'CALL LOG', and 'LANGUAGE'. The 'LANGUAGE' tab is selected. Below the navigation bar, the page is divided into two main sections. The first section is titled 'Language' and contains a 'Language Selection' dropdown menu with 'English' selected. The second section is titled 'Greeting Words' and contains a text input field with the value 'VOIP PHONE' and a note '(0-12 character(s))'. An 'Apply' button is located at the bottom right of the form.

Field name	Explanation
Language	Set the language of phone. English is default.
Greeting Words	The greeting displayed on LCD when phone is idle. It has a maximum of 12 English characters. Default is VOIP PHONE.

8.3.2 Network

8.3.2.1 WAN Config

WAN	LAN	QoS&VLAN	SERVICE PORT	DHCP SERVICE	TIME&DATE
WAN Status					
Active IP Address	192.168.3.48				
Current Subnet Mask	255.255.0.0				
Current IP Gateway	192.168.1.1				
MAC Address	00:a8:59:cc:3c:ba				
MAC Timestamp	20130429				
WAN Settings					
Obtain DNS Server Automatically	Enabled <input type="button" value="v"/>				
Enable Vendor Identifier	Disabled <input type="button" value="v"/>				
Vendor Identifier	<input type="text" value="Fanvil E52/E52P"/>				
Static IP <input type="radio"/>	DHCP <input checked="" type="radio"/>		PPPoE <input type="radio"/>		
<input type="button" value="Apply"/>					
802.1X Settings					
User	<input type="text" value="admin"/>				
Password	<input type="password" value="*****"/>				
Enable 802.1X	<input type="checkbox"/>				
<input type="button" value="Apply"/>					

Field Name	Explanation
Active IP Address	The current IP address of the phone.
Current Subnet Mask	The current Subnet Mask.
Current IP Gateway	The current Gateway IP address.
MAC Address	The MAC address of the phone.
MAC Timestamp	Time the MAC address was obtained.
WAN Settings	
The phone supports three network modes. These are also discussed in Section 2.2.	
<ul style="list-style-type: none"> • Static: Network parameters must be entered manually and will not change. All parameters are provided by the ISP. 	

- DHCP: Network parameters are provided automatically by a DHCP server.
- PPPoE: Account and Password must be input manually. These are provided by your ISP.

8.3.2.1.1 Static IP

If Static IP is chosen, the screen below will appear. Enter values provided by the ISP.

WAN Settings

Static IP DHCP PPPoE

IP Address

Subnet Mask

IP Gateway

DNS Domain

Primary DNS

Secondary DNS

8.3.2.1.2 DHCP

If DHCP is chosen, all configuration information will be provided by a DHCP server. Contact the ISP to determine if DHCP is used.

WAN Settings

Obtain DNS Server Automatically

Enable Vendor Identifier

Vendor Identifier

Static IP DHCP PPPoE

8.3.2.1.3 PPPoE

If PPPoE is chosen, the screen below will appear. Enter the information provided by the ISP.

WAN Settings

Obtain DNS Server Automatically

Static IP DHCP PPPoE

Service Name

User

Password

Service Name	IP Address or name of DSL Server
User	DSL User Name or Login ID
Password	DSL Password

After entering the new settings, click the APPLY button. The phone will save the new settings and apply them. If a new IP address was entered for the phone, it must be used to login to the phone after clicking the APPLY button.

8.3.2.2 LAN Config

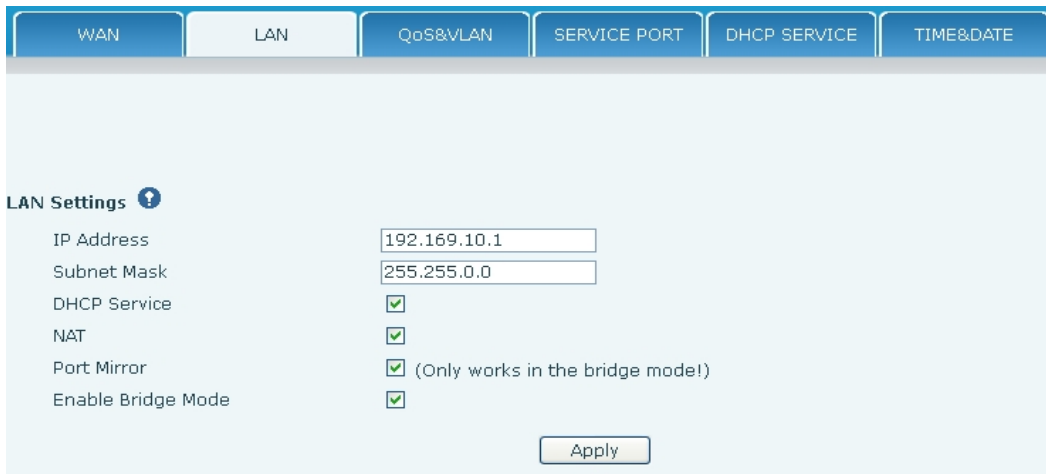

Field Name	Explanation
IP Address	LAN static IP.
Subnet Mask	LAN Subnet Mask.
DHCP Service	Activate DHCP server for LAN port. The phone must be rebooted for the DHCP server setting to take effect.
NAT	Enable NAT operation
Port Mirror	Port Mirror can only be activated in bridge mode. If activated, the data stream from the WAN port is copied to the LAN port of the phone.
Enable Bridge Mode	If Bridge Mode is activated, the phone will not provide an IP address for the LAN port. Instead, the LAN and WAN will be part of the same network. If this is activated, clicking Apply, will cause the

phone will reboot.

Note: When LAN IP or bridge mode status is changed, the system will reboot! If bridge mode is chosen, static LAN configuration will be disabled automatically.

8.3.2.3 Qos & VLAN Config

The phone supports 802.1Q/P protocol and DiffServ configuration. Use of a Virtual LAN (VLAN) allows voice and data traffic to be separated.

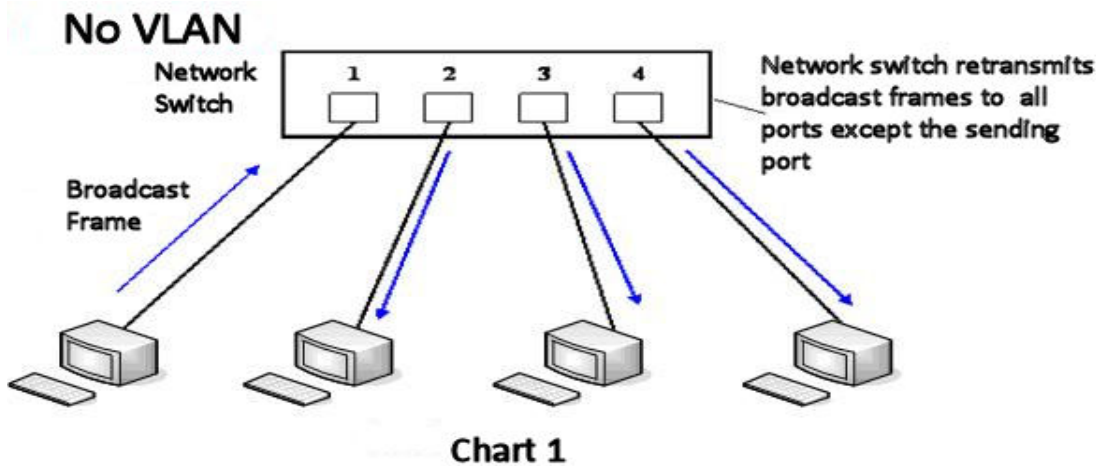

Chart 1 shows a network switch with no VLAN. Any broadcast frames will be transmitted to all other ports. For example, and frames broadcast from Port 1 will be sent to Ports 2, 3, and 4.

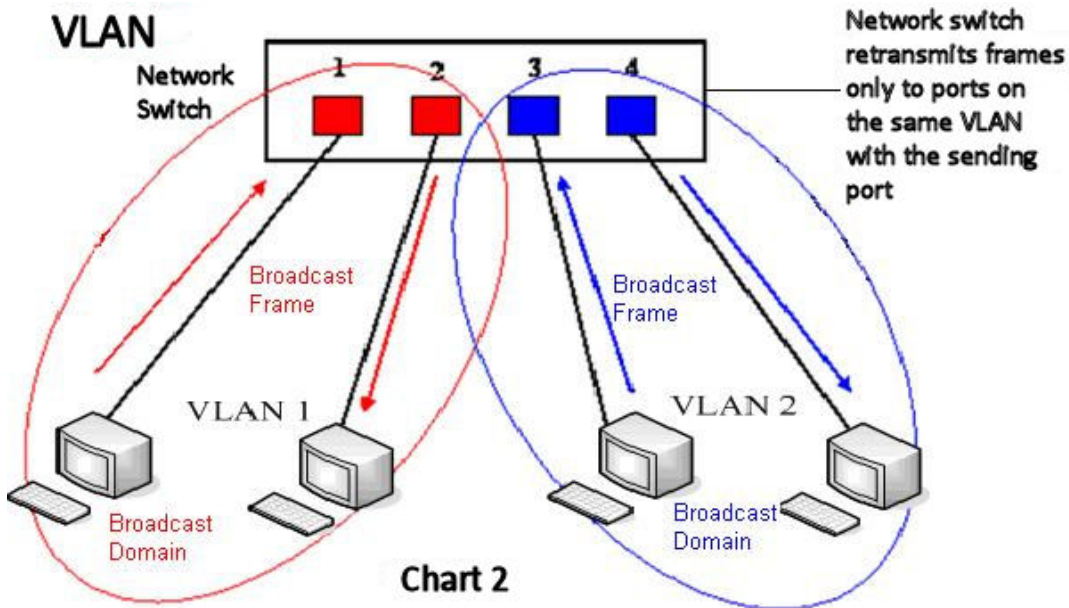

Chart 2 shows an example with two VLANs indicated by red and blue. In this example, frames broadcast from Port 1 will only go to Port 2 since Ports 3 and 4 are in a different VLAN. VLANs can be used to divide a network by restricting the transmission of broadcast frames.

Note: In practice, VLANs are distinguished by the use of VLAN IDs.

WAN	LAN	QoS&VLAN	SERVICE PORT	DHCP SERVICE	TIME&DATE
Link Layer Discovery Protocol (LLDP) Settings					
Enable LLDP		<input type="checkbox"/>	Packet Interval(1~3600) <input type="text" value="60"/> second(s)		
Enable Learning Function		<input type="checkbox"/>			
Quality of Service (QoS) Settings					
Enable DSCP		<input type="checkbox"/>	SIP DSCP <input type="text" value="46"/> (0~63)		
Audio RTP DSCP		<input type="text" value="46"/> (0~63)			
WAN Port VLAN Settings					
Enable WAN Port VLAN		<input type="checkbox"/>	WAN Port VLAN ID <input type="text" value="256"/> (0~4095)		
SIP 802.1P Priority		<input type="text" value="0"/> (0~7)	Audio 802.1P Priority <input type="text" value="0"/> (0~7)		
LAN Port VLAN Settings					
LAN Port VLAN Mode		<input type="text" value="Follow WAN"/>	LAN Port VLAN ID <input type="text" value="254"/> (0~4095)		
<input type="button" value="Apply"/>					

Field Name	Explanation
Enable LLDP	Enable or Disable Link Layer Discovery Protocol (LLDP)
Packet Interval	The time interval for sending LLDP Packets
Enable Learning Function	Enables the telephone to synchronize its VLAN data with the Network Switch. The telephone will automatically synchronize DSCP, 802.1p, and VLAN ID values even if these values differ from those provided by the LLDP server.
Enable DSCP	Enable or Disable Differentiated Services Code Point (DSCP)
SIP DSCP	Specify the value of the SIP DSCP in decimal
Audio DSCP	Specify the value of the Audio DSCP in decimal
Enable WAN Port VLAN	Enable or Disable WAN Port VLAN
WAN Port VLAN ID	Specify the value of the WAN Port VLAN ID. Range is 0-4095
SIP 802.1P Priority	Specify the value of the voice 802.1p priority. Range is 0-7
Audio 802.1P Priority	Specify the value of the signal 802.1p priority. Range is 0-7
LAN Port VLAN Mode	Follow WAN: LAN Port ID is same as WAN ID

	Disable: Disable Port VALN Enable: Specify a VLAN ID for the LAN port which is different from WAN ID
LAN Port VLAN ID	Used when the VLAN ID is different from WAN ID. Range is 0-4095

8.3.2.4 Service Port

Set the port values for Telnet/HTTP/RTP on this page.

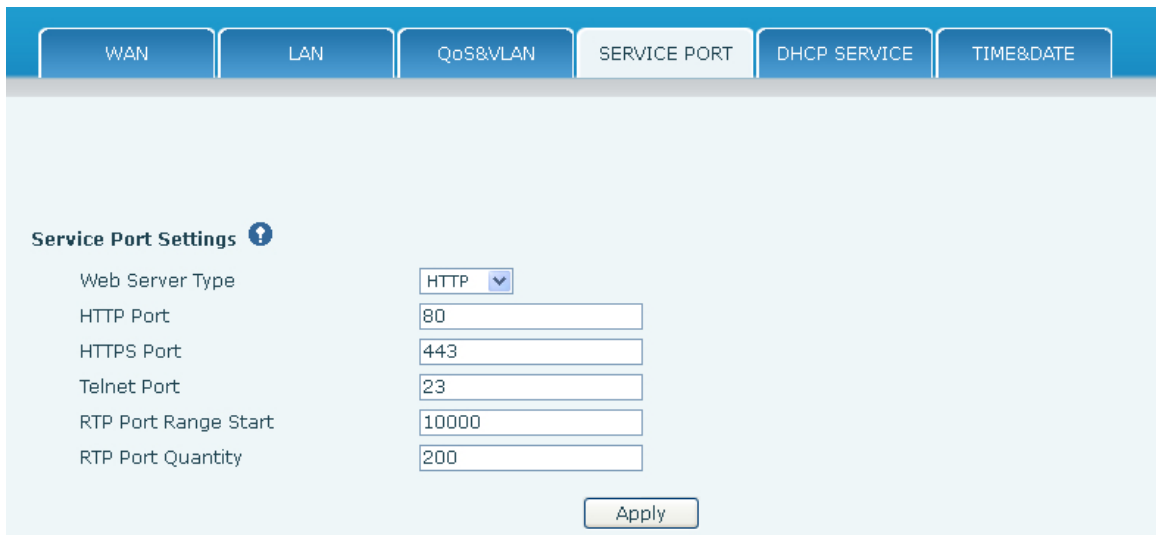

Field Name	Explanation
Web Server Type	Specify Web Server Type – HTTP or HTTPS
HTTP Port	Port for web browser access. Default value is 80. To enhance security, change this from the default. Setting this port to 0 will disable HTTP access. Example: The IP address is 192.168.1.70 and the port value is 8090, the accessing address is http://192.168.1.70:8090.
HTTPS Port	Port for HTTPS access. Before using https, an https authentication certification must be downloaded into the phone. Default value is 443. To enhance security, change this from the default.
Telnet Port	Port for Telnet access. The default is 23.

RTP Port Range Start	Set the beginning value for RTP Ports. Ports are dynamically allocated.
RTP Port Quantity	Set the maximum quantity of RTP Ports. The default is 200.
Notes: 8. Any changes made on this page require a reboot to become active. 9. It is suggested that changes to HTTP Port and Telnet ports be values greater than 1024. Values less than 1024 are reserved. 10. If the HTTP port is set to 0, HTTP service will be disabled.	

8.3.2.5 DHCP SERVICE

WAN
LAN
QoS&VLAN
SERVICE PORT
DHCP SERVICE
TIME&DATE

DHCP Client Table

Leased IP Address	Client MAC Address

DHCP Lease Table

Name	Start IP	End IP	Leased Time	Subnet Mask	IP Gateway	DNS

DHCP Lease Table Settings

Leased Table Name

Start IP Address

End IP Address

Leased Time minute(s)

Subnet Mask

IP Gateway

DNS Server Address

DHCP Lease Table Delete

Leased Table Name

DNS Relay

Enable DNS Relay

Field Name	Explanation
DHCP Client Table	IP-MAC mapping table. If the LAN port of the phone connects to a device, this table will show its IP and MAC address.
Leased Table Name	Name of the lease table.
Start IP Address	Beginning IP address of the lease table.
End IP Address	Ending IP address of the lease table. A device connected to the LAN port will get an IP address between Start IP and End IP.
Subnet Mask	Subnet Mask of the lease table.
IP Gateway	Network Gateway of the lease table.
Leased Time	Time IP address assignments will persist. Unit is minutes.
DNS Server Address	IP address of DNS server.
Add	Click this button to add this lease table
DHCP Lease Table Delete	Enter the table name and click the Delete button to remove a DHCP lease table.
Enable DNS Relay	Activates DNS Relay in the phone. Default is enabled.
Notes: 11. The size of lease table cannot be larger than the quantity of C network IP address. It is recommended to use the default lease table without modification 12. If the DHCP lease table is modified, the phone must be rebooted.	

8.3.2.6 TIME&DATE

Set the time zone and SNTP (Simple Network Time Protocol) server on this page. Daylight savings time configuration and manual time and date entry are also done on this page

WAN
LAN
QoS&VLAN
SERVICE PORT
DHCP SERVICE
TIME&DATE

Simple Network Time Protocol (SNTP) Settings

Enable SNTP
 Enable DHCP Time
 Primary Server
 Secondary Server
 Timezone
 Resync Period second(s)
 12-Hour Clock
 Date Format

Daylight Saving Time Settings

Enable
 Offset minutes(s)
 Month
 Week
 Day
 Hour
 Minute

Manual Time Settings

Year
 Month
 Day
 Hour
 Minute

Field Name	Explanation
Simple Network Time Protocol (SNTP) Settings	
Enable SNTP	Enable or Disable SNTP
Enable DHCP Time	If this is enabled, phone will synchronize time with DHCP server.
Primary Server	IP address of Primary SNTP Server
Secondary Server	IP address of Secondary SNTP Server
Time Zone	Local Time Zone

Resync Period	Time between resync to SNTP server. Default is 60 seconds.
12 -Hour Clock	If checked, clock is 12 hour mode. If unchecked, 24 hour mode. Default is 24 hour mode.
Date Format	Specify the date format. Fourteen different formats are available.
Date Separator	Four date separators are available: /, -, ., space
Daylight Saving Time Settings	
Enable	Enable daylight saving time.
Offset(minutes)	DST offset. Default is 60 minutes.
Month	Start and end month for DST
Week	Start and end week for DST
Day	Start and end day for DST
Hour	Start and end hour for DST
Minute	Start and end minute for DST
Manual Time Settings	
Enter the values for the current year, month, day, hour and minute. All values are required.	
Note: Be sure to disable SNTP service before entering manual time and date.	

8.3.3 VOIP

8.3.3.1 SIP Configuration

Configure a SIP server on this page.

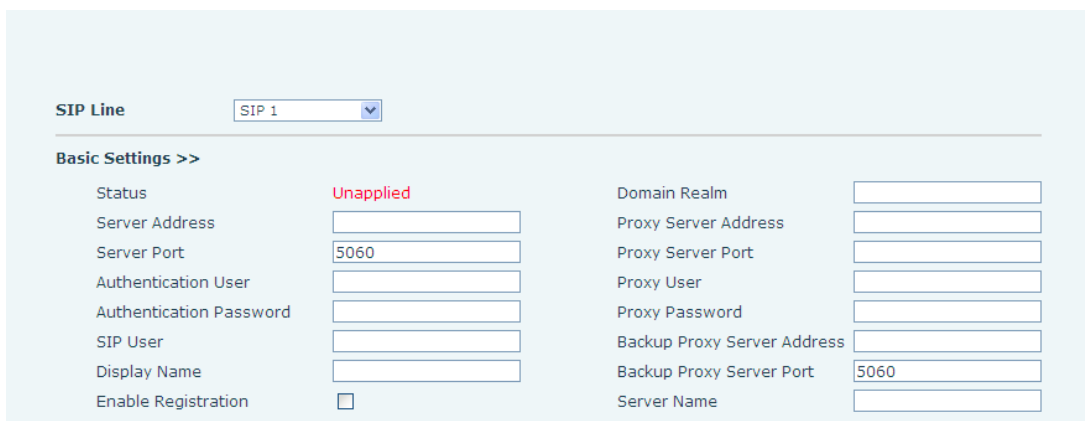

SIP Line: SIP 1

Basic Settings >>

Status	Unapplied	Domain Realm	<input type="text"/>
Server Address	<input type="text"/>	Proxy Server Address	<input type="text"/>
Server Port	5060	Proxy Server Port	<input type="text"/>
Authentication User	<input type="text"/>	Proxy User	<input type="text"/>
Authentication Password	<input type="text"/>	Proxy Password	<input type="text"/>
SIP User	<input type="text"/>	Backup Proxy Server Address	<input type="text"/>
Display Name	<input type="text"/>	Backup Proxy Server Port	5060
Enable Registration	<input type="checkbox"/>	Server Name	<input type="text"/>

Codecs Settings >>

Disabled Codecs

G.711A
G.711U
G.722
G.723.1
G.726-32
G.729AB



Enabled Codecs



Advanced SIP Settings >>

Forward Type	<input type="text" value="Disabled"/>	Enable Hotline	<input type="checkbox"/>
Forward Number	<input type="text"/>	Hotline Number	<input type="text"/>
No Ans. Fwd Wait Time	<input type="text" value="60"/> (0~120)second(s)	Warm Line Wait Time	<input type="text" value="0"/> (0~9)second(s)
Transfer Timeout	<input type="text" value="0"/> second(s)		
SIP Encryption	<input type="checkbox"/>	Enable Auto Answer	<input type="checkbox"/>
SIP Encryption Key	<input type="text"/>	Auto Answer Timeout	<input type="text" value="60"/> second(s)
RTP Encryption	<input type="checkbox"/>	Enable Session Timer	<input type="checkbox"/>
RTP Encryption Key	<input type="text"/>	Session Timeout	<input type="text" value="0"/> second(s)
Subscribe For MWI	<input type="checkbox"/>	Conference Type	<input type="text" value="Local"/>
MWI Number	<input type="text"/>	Conference Number	<input type="text"/>
Subscribe Period	<input type="text" value="3600"/> second(s)	Registration Expires	<input type="text" value="3600"/> second(s)
Enable Service Code	<input type="checkbox"/>		
DND On Code	<input type="text"/>	DND Off Code	<input type="text"/>
Always CFwd On Code	<input type="text"/>	Always CFwd Off Code	<input type="text"/>
Busy CFwd On Code	<input type="text"/>	Busy CFwd Off Code	<input type="text"/>
No Ans. CFwd On Code	<input type="text"/>	No Ans. CFwd Off Code	<input type="text"/>
Ban Anonymous On Code	<input type="text"/>	Ban Anonymous Off Code	<input type="text"/>

Keep Alive Type	<input type="text" value="SIP Option"/>	Keep Alive Interval	<input type="text" value="60"/> second(s)
User Agent	<input type="text"/>	Server Type	<input type="text" value="COMMON"/>
DTMF Type	<input type="text" value="AUTO"/>	RFC Protocol Edition	<input type="text" value="RFC3261"/>
DTMF SIP INFO Mode	<input type="text" value="Send 10/11"/>	Local Port	<input type="text" value="5060"/>
Ring Type	<input type="text" value="Default"/>	Anonymous Call Edition	<input type="text" value="None"/>
Enable Rport	<input type="checkbox"/>	Keep Authentication	<input type="checkbox"/>
Enable PRACK	<input type="checkbox"/>	Ans. With a Single Codec	<input type="checkbox"/>
Enable Long Contact	<input type="checkbox"/>	Auto TCP	<input type="checkbox"/>
Convert URI	<input checked="" type="checkbox"/>	Enable Strict Proxy	<input type="checkbox"/>
Dial Without Registered	<input type="checkbox"/>	Enable GRUU	<input type="checkbox"/>
Ban Anonymous Call	<input type="checkbox"/>	Enable Displayname Quote	<input type="checkbox"/>
Enable DNS SRV	<input type="checkbox"/>	Enable user=phone	<input checked="" type="checkbox"/>
Enable Missed Call Log	<input checked="" type="checkbox"/>	Click To Talk	<input type="checkbox"/>
Transport Protocol	<input type="text" value="UDP"/>	Use VPN	<input checked="" type="checkbox"/>
Respond 182 when Call waiting	<input type="checkbox"/>	Enable DND	<input type="checkbox"/>

Apply

Keep Alive Type	SIP Option	Keep Alive Interval	60 second(s)
User Agent		Server Type	COMMON
DTMF Type	AUTO	RFC Protocol Edition	RFC3261
DTMF SIP INFO Mode	Send 10/11	Local Port	5060
Ring Type	Default	Anonymous Call Edition	None
Enable Rport	<input type="checkbox"/>	Keep Authentication	<input type="checkbox"/>
Enable PRACK	<input type="checkbox"/>	Ans. With a Single Codec	<input type="checkbox"/>
Enable Long Contact	<input type="checkbox"/>	Auto TCP	<input type="checkbox"/>
Convert URI	<input checked="" type="checkbox"/>	Enable Strict Proxy	<input type="checkbox"/>
Dial Without Registered	<input type="checkbox"/>	Enable GRUU	<input type="checkbox"/>
Ban Anonymous Call	<input type="checkbox"/>	Enable Displayname Quote	<input type="checkbox"/>
Enable DNS SRV	<input type="checkbox"/>	Enable user=phone	<input checked="" type="checkbox"/>
Enable Missed Call Log	<input checked="" type="checkbox"/>	Click To Talk	<input type="checkbox"/>
BLF List Number		Transport Protocol	UDP
Enable BLF List	<input type="checkbox"/>	Use VPN	<input checked="" type="checkbox"/>
Respond 182 when Call waiting	<input type="checkbox"/>	Enable DND	<input type="checkbox"/>

SIP Global Settings >>

Strict Branch	<input type="checkbox"/>	Enable Group	<input type="checkbox"/>
Registration Failure Retry Time	32 second(s)		

Field Name	Explanation
	Choose the sip line to configured (SIP 1 – SIP2). Click the dropdown arrow to select the line.
Status	Shows registration status. Will show “Registered” if registered or “Unapplied” if not registered.
Server Address	SIP server IP address or URI.
Server Port	SIP server port. Default is 5060.
Authentication User	SIP account name (Login ID).
Authentication Password	SIP registration password.
SIP User	Phone number assigned by VoIP service provider. Phone will not register if there is no phone number configured.
Display Name	Set the display name. This name is shown on Caller ID.
Enable Registration	Check to submit registration information.
Domain Realm	SIP Domain if different than the SIP Registrar Server.
Proxy Server Address	SIP proxy server IP address or URI (This is normally the same as the SIP Registrar Server)
Proxy Server Port	SIP Proxy server port. Normally 5060.
Proxy User	SIP Proxy server account.
Proxy Password	SIP Proxy server password.
Backup Server Address	Backup SIP Server Address or URI (This server will be used if the

	primary server is unavailable)
Backup Server Port	Backup SIP Server Port
Server Name	Name of SIP Backup server
Codecs Settings	
Click on the desired codec to select it. Then use the vol-/vol+ keys to move to the Enabled or Disabled List. Use the Up/Down arrow to change the priority of enabled codecs.	
Advanced SIP Settings	
Forward Type	There are 3 call forwarding modes plus Disabled. Disabled: No call forwarding – Default mode Busy: If the phone is busy, incoming calls will be forwarded. No answer: If there is no answer, incoming calls will be forwarded after a specified time. Always: All incoming calls will be forwarded.
Forward Number	Number to which calls are to be forwarded.
No Ans. Fwd Wait Time	Used in conjunction with Call Forward No Answer. Wait time in seconds before call is forwarded.
Transfer Timeout	Time interval between sending “bye” message and hanging up after the phone transfers a call.
Enable Hotline	Activate Hot Line feature. Automatically call a number by going off hook.
Hotline Number	Number to be called in Hot Line Mode.
Warm Line Wait Time	Used in Hot Line Mode. Time the phone waits after off hook before dialing the hot line number.
SIP Encryption	Enable/Disable SIP Encryption.
SIP Encryption Key	SIP Encryption key.
RTP Encryption	Enable/Disable RTP Encryption.
RTP Encryption Key	RTP encryption key
Enable Auto Answer	Activate Auto Answer mode. If activated, phone will automatically answer an incoming call.
Auto Answer Timeout	Used in conjunction with Auto Answer. The phone will answer an incoming call after the Auto Answer Timeout
Enable Session Timer	If enabled, this will refresh the SIP session timer per RFC4028.
Session Timeout	Refresh interval if Session Timer is enabled.
Subscribe For MWI	If enabled, the phone will send Message Waiting Indication (MWI) Subscribe message to the SIP Server
MWI Number	Specify the number to call to retrieve Voice Messages.

Subscribe Period	Time interval between MWI Subscribe Messages.
Conference Type	Choose Conference Type, either local or network
Conference Number	Number to dial to access network conference server. Not needed if Local conference mode is chosen
Registration Expires	SIP re-registration time. Default is 3600 seconds. If the server requests a different time, the phone will change to that value.
Enable Service Code	Enables or disables the services described below. These codes will be sent to the SIP server to activate or deactivate the service.
DND On Code	Do Not Disturb (DND) – When this hot key is pressed, all calls to the extension to be rejected by the server. The incoming call record will not be displayed in the Call History.
DND Off Code	Disable Server DND as described above.
Always CFwd On Code	Always Call Forward On – When this function is enabled, the server will forward all calls to a designated number. The incoming call record will not be displayed in the Call History.
Always CFwd Off Code	Disable Server Always CFwd as described above.
Busy CFwd On Code	Busy Call Forward On - When this function is enabled, the server will forward all calls to a designated number if the telephone is busy. The call record will not be displayed in Call History.
Busy CFwd Off Code	Disable Server Busy CFwd as described above.
No Ans. CFwd On Code	No Answer Call Forward On - When this function is enabled, the server will forward all calls to a designated number if there is no answer within a designated time. The incoming call record will not be displayed in the Call History.
No Ans. CFwd Off Code	Disable Server No Ans. CFwd as described above.
Ban Anonymous On Code	Ban Anonymous On – When this function is enabled, the server will disallow the phone to make anonymous calls.
Ban Anonymous Off Code	Allow Anonymous Calling function described above. In other words “Anonymous” will be transmitted for Caller ID.
Keep Alive Type	Specifies the NAT keep alive type. If SIP Option is selected, the phone will send SIP Option sip messages to the server every NAT Keep Alive Period. The server will then respond with 200 OK. If UDP is selected, the phone will send a UDP message to the server every NAT Keep Alive Period.
Keep Alive Interval	Set the NAT Keep Alive Interval. Default is 60 seconds
User Agent	Set SIP User Agent value.
DTMF SIP INFO Mode	You can chose Send 10/11 or Send */#

DTMF Type	DTMF sending mode. There are four modes: <ul style="list-style-type: none"> ● In-band ● RFC2833 ● SIP_INFO ● AUTO Different VoIP Service providers may require different modes.
Local port	SIP port. Default is 5060.
Ring type	Set ring tone. There are 9 standard options and 3 user options.
Enable Rport	Enable/Disable support for NAT traversal via RFC3581 (Rport).
Enable PRACK	Enable or disable SIP PRACK function. Default is OFF. It is suggested this be used.
Enable Long Contact	Allow more parameters in contact field per RFC 3840
Convert URI	Converts # to %23 when sending URI information.
Dial Without Registered	Allow outgoing calls without registration.
Ban Anonymous Call	Refuse Anonymous Calls
Enable DNS SRV	Enables use of DNS SRV records
Enable Missed Call Log	If enabled, the phone will save missed calls into the call history record.
Server Type	Configures phone for unique requirements of selected server.
RFC Protocol Edition	Select SIP protocol version RFC3261 or RFC2543. Default is RFC3261. Used for servers which only support RFC2543.
Transport Protocol	Set transport protocol TCP, UDP or TLS.
Anonymous Call Edition	Set privacy support RFC3323, RFC3325 or none
Keep Authentication	Enable /disable registration with authentication. It will use the last authentication field which passed authentication by server. This will decrease the load on the server if enabled.
Ans. With a Single Codec	If enabled phone will respond to incoming calls with only one codec.
Auto TCP	Force the use of TCP protocol to guarantee usability of transport for SIP messages above 1500 bytes
Enable Strict Proxy	Enables the use of strict routing. When the phone receives packets from the server, it will use the source IP address, not the address in via field.
Enable GRUU	Support for Globally Routable User-Agent URI (GRUU)
Enable Displayname Quote	Puts quotation marks around the display-name in SIP messages. For servers that require this.
Enable user=phone	Sets user=phone in SIP messages. For compatibility with servers

	that require this.
Click to Talk	Set click to Talk (needs support from server).
Respond 182 when Call waiting	Enable phone responds 182 instead of 180 in some SIP server environment
Use VPN	Enable SIP use VPN for every line individually, not all of them
Enable DND	Enable DND for SIP line individually
SIP Global Settings	
Strict Branch	Enable Strict Branch - The value of the branch must be after "z9hG4bK" in the VIA field of the INVITE message received, or the phone will not respond to the INVITE. Note: This will affect all lines
Enable Group	Enable SIP Group Backup. This will affect all lines
Registration Failure Retry Time	Registration failure retry time – If registration fails, the phone will attempt to register again after registration failure retry time. This will affect all lines

8.3.3.2 IAX2

IAX2

Status Unapplied

Server Address

Server Port

Account

Password

Phone Number

Local Port

Voice Mail Number

Voice Mail Text

Echo Test Number

Echo Test Text

Refresh Time second(s)

Enable Registration

Enable G.729AB

Field Name	Explanation
Status	Shows registration status. Will show “Registered” if registered or “Unapplied” if not registered.
Server Address	IAX2 server address.
Server Port	IAX2 server port. Default is 4569.
Account	IAX2 account name for registration
Password	IAX2 registration password.
Phone Number	IAX2 phone number (usually the same as IAX2 account name).
Local Port	IAX2 local port. Default is 4569.
Voice Mail Number	Voice mail number.
Voice Mail Text	Voice mail name.
Echo Test Number	If the IAX2 server supports echo test and the echo test number is non-numeric, this number can be used to replace the echo test text. This allows dialing a number to perform an echo voice test. This function is provided to test whether communication through the server.
Echo Test Text	Echo test text
Refresh Time	Expiration time of IAX2 server registration. Allowed values are between 60 and 3600 seconds.
Enable Registration	Enable/Disable IAX2 registration.
Enable G.729AB	Enable/Disable G.729 codec.

8.3.3.3 STUN Config

STUN support is configured in this page.

STUN – Simple Traversal of UDP through NAT – A STUN server allows a phone in a private network to know its public IP and port as well as the type of NAT being used. The phone can then use this information to register itself to a SIP server so that it can make and receive calls while in a private network.

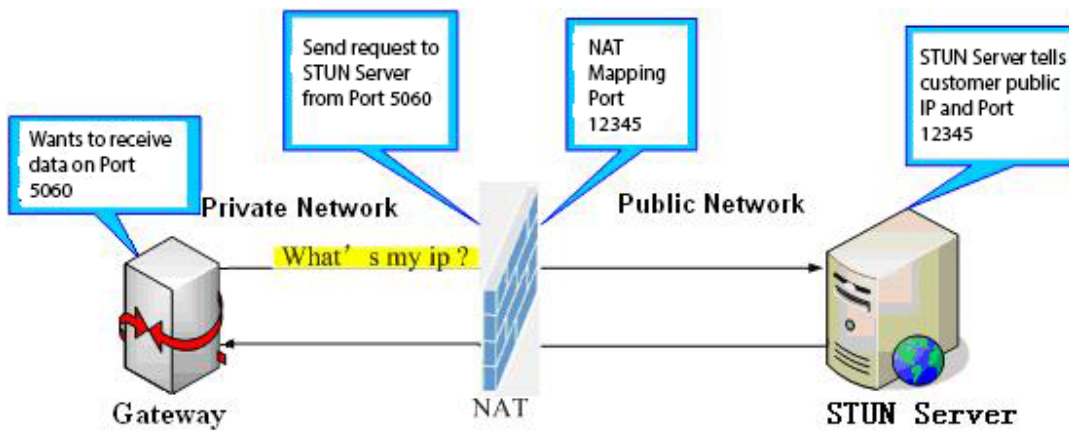

Simple Traversal of UDP through NATs (STUN) Settings

STUN NAT Traversal: **FALSE**

Server Address:

Server Port:

Binding Period: second(s)

SIP Waiting Time: millisecond(s)

Local SIP Port:

SIP Line Using STUN

SIP 1

Use STUN:

Field Name	Explanation
STUN NAT Transversal	Shows whether or not STUN NAT Transversal was successful.
Server Address	STUN Server IP address
Server Port	STUN Server Port – Default is 3478.
Binding Period	STUN blinding period – STUN packets are sent at this interval to keep the NAT mapping active.
SIP Waiting Time	Waiting time for SIP. This will vary depending on the network.
Local SIP Port	Local SIP Port- Default is 5060
SIP Line Using STUN	

SIP Line Using STUN	Select the Line for use with STUN (SIP 1 - SIP 6)
Use STUN	Enable/Disable STUN on the selected line.

8.3.3.4 DIAL PEER

This feature allows the user to create rules to make dialing easier. There are several different options for dial rules. The examples below will show how this can be used.

Example 1: Substitution – Assume that it is desired to place a direct IP call to IP address 192.168.119. Using this feature, 156 can be substituted for 192.168.1.119.

Dial Peer Table

Number	Destination	Port	Mode	Alias	Suffix	Del Length
156	192.168.1.119	5060	SIP	no alias	no suffix	0

Example 2: Substitution – To dial a long distance call to Beijing requires dialing area code 010 before the local phone number. Using this feature 1 can be substituted for 010. For example, to call 62213123 would only require dialing 162213123 instead of 01062213123.

Dial Peer Table

Number	Destination	Port	Mode	Alias	Suffix	Del Length
1T	0.0.0.0	5060	SIP	rep:010	no suffix	1

Number	Destination	Port	Mode	Alias	Suffix	Deleted Length
13[2-9]xxxxxxxx	0.0.0.2	5060	SIP	add:0	no suffix	0
156	192.168.1.24	5060	SIP	no alias	no suffix	0
1T	0.0.0.2	5060	SIP	rep:010	no suffix	1
138xxxxxxxx	0.0.0.2	5060	SIP	add:0	no suffix	0

Example 3: Addition – Two examples are shown. In the first case, it is assumed that 0 must be dialed before any 11 digit number beginning with 13. In the second case, it is assumed that 0 must be dialed before any 11 digit number beginning with 135, 136, 137, 138, or 139. Two different special characters are used.

x – Matches any single digit that is dialed.

[] – Specifies a range of numbers to be matched. It may be a range, a list of ranges separated by commas, or a list of digits.

Number	Destination	Port	Mode	Alias	Suffix	Deleted Length
13[2-9]xxxxxxxx	0.0.0.2	5060	SIP	add:0	no suffix	0
156	192.168.1.24	5060	SIP	no alias	no suffix	0
1T	0.0.0.2	5060	SIP	rep:010	no suffix	1
138xxxxxxxx	0.0.0.2	5060	SIP	add:0	no suffix	0

Add Dial Peer

Phone Number

Destination(Optional)

Port(Optional)

Alias(Optional)



Call Mode

Suffix(Optional)

Deleted Length(Optional)

Dial Peer Option

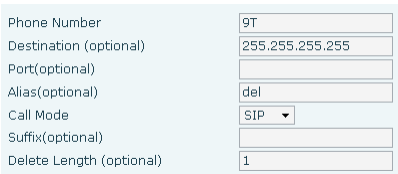
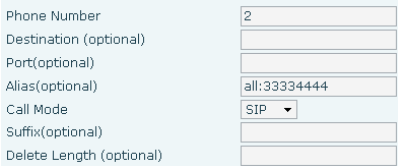
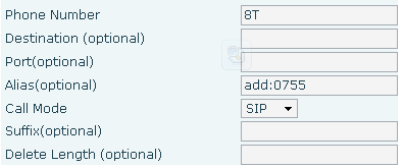
Field Name	Explanation
Phone number	There are two types of matching: Full Matching or Prefix Matching. In Full matching, the entire phone number is entered and then mapped per the Dial Peer rules. In prefix matching, only part of the number is entered followed by T. The mapping with then take place whenever these digits are dialed. Prefix mode supports a maximum of 30 digits.
Destination	Set Destination address. This is optional. For a peer to peer call, enter the destination IP address or domain name. To use a dial rule on the SIP2 line, enter 0.0.0.2.
Port	Set the Signaling port, the default is 5060.
Alias	Set the Alias. This is the text to be added, replaced, or deleted. It is optional.
<p>Note: There are four types of aliases.</p> <ol style="list-style-type: none"> 1) Add: xxx – xxx will be dialed before any phone number. 2) All: xxx – xxx will replace the phone number. 3) Del: The characters will be deleted from the phone number. 4) Rep: xxx – xxx will be substituted for the specified characters. 	

Call Mode	Select either SIP or IAX2 protocol.	
Suffix	Characters to be added at the end of the phone number. This is optional.	
Delete Length	Sets the number of characters to be deleted. For example, if this is set to 3, the phone will delete the first 3 digits of the phone number. This is optional.	
Dial Peer Examples		
Web Interface	Explanation	Example
 <p>Phone Number: 9T Destination (optional): 255.255.255.255 Port(optional): Alias(optional): del Call Mode: SIP Suffix(optional): Delete Length (optional): 1</p>	Set phone number, Destination, Alias and Delete Length. Phone number is XXXT; Destination is 255.255.255.255 (0.0.0.2) and Alias is del. Any phone number that begins with XXX will be sent via SIP2 after the first several digits are deleted depending on the delete length.	Dial “93333” The SIP2 server will receive “3333”
 <p>Phone Number: 2 Destination (optional): Port(optional): Alias(optional): all:33334444 Call Mode: SIP Suffix(optional): Delete Length (optional):</p>	This creates a speed dial function. Dialing “2”, will cause the entire alias number to be sent out.	Dial “2” The SIP1 server will receive 33334444
 <p>Phone Number: 8T Destination (optional): Port(optional): Alias(optional): add:0755 Call Mode: SIP Suffix(optional): Delete Length (optional):</p>	The phone will add the alias to the end of the dialed number if the dialed number matches the template in the Phone Number box.	Dial “8309” The SIP1 server will receive “07558309”
 <p>Phone Number: 010T Destination(Optional): Port(Optional): Alias(Optional): rep:8610 Call Mode: SIP Suffix(Optional): Deleted Length(Optional): 3</p>	Set Phone Number, Alias and Delete Length. Phone number is XXXT and Alias is rep: xxx If the dialed phone number starts with the digits in the Phone Number box, the matching digits will be replaced by the alias number.	Dial “0106228” The SIP1 server will receive “86106228”

Phone Number <input type="text" value="147"/> Destination (optional) <input type="text"/> Port(optional) <input type="text"/> Alias(optional) <input type="text"/> Call Mode <input type="text" value="SIP"/> Suffix(optional) <input type="text" value="0011"/> Delete Length (optional) <input type="text"/>	If the dialed phone number starts with the digits in the Phone Number box, the phone will send out the dialed phone number and add the suffix number.	Dial “147” The SIP1 server will receive “1470011”
--	---	--

8.3.4 Phone

8.3.4.1 AUDIO

This page configures audio parameters such as voice codec, handset volume, and ringer volume.

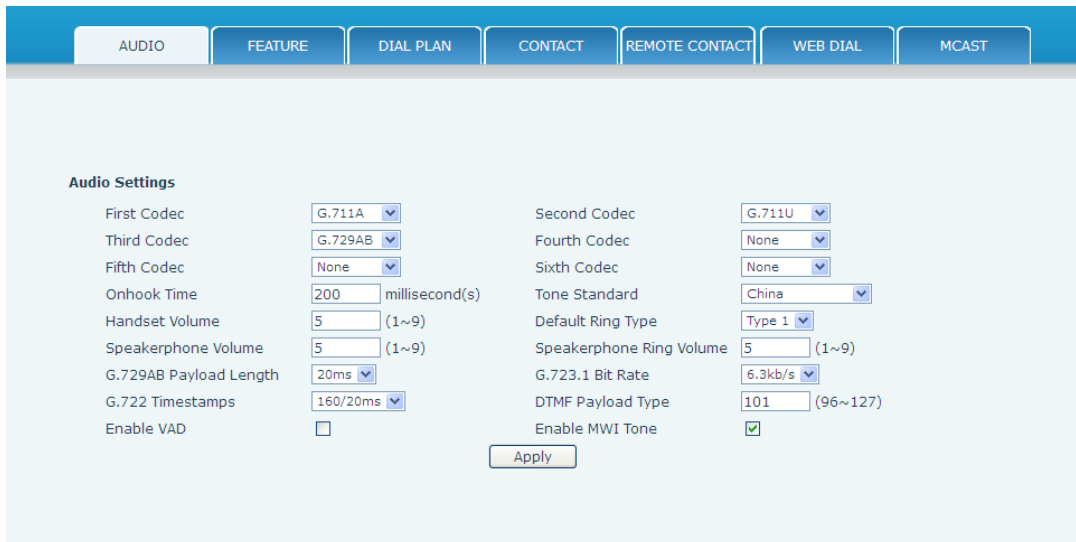

Field Name	Explanation
First Codec	The first codec choice: G.711A, G.711A u, G.722, G.723.1, G.729AB, G.726-32
Second Codec	The second codec choice: G.711A, G.711A u, G.722, G.723.1, G.729AB, G.726-32, None
Third Codec	The third codec choice: G.711A, G.711A u, G.722, G.723.1, G.729AB, G.726-32, None
Fourth Codec	The forth codec choice: G.711A, G.711A u, G.722, G.723.1, G.729AB, G.726-32, None
Fifth Codec	The fifth codec choice G.711A, G.711A u, G.722, G.723.1, G.729AB, G.726-32, None

Sixth codec	The sixth codec choice G.711A, G.711A u, G.722, G.723.1, G.729AB, G.726-32, None
Onhook Time	Time the handset must be on hook to disconnect a call. Default is 200ms.
Default Ring Type	Ring Sound – There are 9 standard types and 3 User types
Handset Volume	Handset Microphone volume – 9 levels
Speakerphone Volume	Speaker volume in hands free mode - 9 levels
Speakerphone Ring Volume	Speaker Ring Volume - 9 levels
G729AB Payload Length	G729AB Payload Length – Adjusts from 10 – 60 mSec
Tone Standard	Select tone plan for the country of operation
G722 Timestamps	Choices are 160/20ms or 320/20ms
G723.1 Bit Rate	Choices are 5.3kb/s or 6.3kb/s
Enable VAD	Enable or disable Voice Activity Detection (VAD). If VAD is enabled, G729 Payload length cannot be set greater than 20 mSec.
DTMF Payload Type	The RTP Payload type that indicates DTMF. Default is 101
Enable MWI Tone	Enable special dialing tone as MWI indication, if PBX supports the special MWI tone indication.

8.3.4.2 FEATURE

This page configures various features such as Hotline, Call Transfer, Call Waiting, etc.

Field Name	Explanation
DND (Do Not Disturb)	DND might be disabled, phone for all SIP lines, or line for SIP individually.
Enable Call Transfer	If enabled, Call Transfer is allowed.
Semi-Attended Transfer	If enabled, Semi-Attended Transfer is allowed.
Enable Auto Handdown	If enabled in speakerphone mode, the phone will automatically hang up and return to idle when the distant party terminates the call. In handset mode, it will play dial tone instead of returning to idle.
Auto Handdown Time	Wait time before the phone performs the Auto Handdown behavior described above.
Enable Auto Redial	If enabled, the phone will automatically redial a call if a busy tone is received.
Auto Redial Interval	Wait time between auto redial attempts in seconds.
Auto Redial Times	Maximum number of auto redial attempts.

Enable Intercom	If enabled, allows intercom calls.
Enable Intercom Tone	If enabled, plays intercom ring tone to alert to an intercom call.
P2P IP Prefix	Set Prefix for peer to peer IP call. For example: You wish to dial 192.168.1.119. If the P2P IP Prefix is defined as 192.168.1., it is only necessary to dial #119. The default is “.”. If this box is left blank, IP dialing is disabled.
Turn Off Power Light	Disables Power Light if selected.
Emergency Call Number	The phone will dial the emergency call number even if the keyboard is locked. And multi numbers can be added by “;”, such as 911,999
Enable Password Dial	When a number is entered beginning with the password prefix, the following N numbers after the password prefix will be displayed as *. N is the value entered in the Password Length field. For example: If the password prefix is 3 and the Password Length is 2, then dialing the number 34567 will display 3**67 on the phone.
Password Dial Prefix	Prefix for password dialing as described above.
Password Dial Length	Length for password dialing as described above.
Enable Call History	Allow phone to save missed call/dialed call/incoming call or not.
Enable Default Line	If enabled, you can assigned default SIP line for dialing out, not SIP1.
Allow IP Call	Allow IP direct call, or disable IP call for dialing.
Play Talking DTMF Tone	Allow DTMF voice played during talking, or only send DTMF without local play.
Ban Outgoing	If enabled, no outgoing calls can be made.
Enable Call Waiting	If enabled, notifies user of a second call during a call. Caller ID of the new caller will be displayed. Press HOLD button to place existing call on hold and answer new call. Press HOLD again to return to first call.
Enable 3-way Conference	If enabled, allows 3-way conference.
Accept Any Call	If enabled, the phone will accept a call even if the called number does not belong to the phone.
Enable Call Completion	This is similar to Auto Redial except that the phone detects the state of the called number before making a new call attempt.
Enable Pre-Dial	If this feature is enabled, digits dialed on-hook will be transmitted when the phone goes off-hook.
Enable Silent Mode	If enabled, the phone will not ring to indicate a new call. Instead, the light below the key pad will blink to indicate a new call.

Hide DTMF	<p>This feature sets how DTMF digits are displayed after a call is in progress. For example, dialing a PIN code to access banking information. There are 4 choices.</p> <p>13. Disabled – All the digits will be shown on the LCD.</p> <p>14. All – None of the digits will be shown on the LCD. The “*” will be shown.</p> <p>15. Delay – The last digit entered will be shown for a short time and then replaced by “*.”</p> <p>16. Last Show – The last digit entered will be shown. Previous digits are replaced by “*.”</p>
Enable Intercom Mute	If enabled, mutes incoming calls during an intercom call
Enable Intercom Barge	If enabled, the phone will auto-answer an intercom call during an outside call. If an intercom call is established, a second intercom call will be rejected.
DND Return Code	Specify SIP Code returned for DND. Default is 480 - Temporarily Not Available.
Busy Return Code	Specify SIP Code returned for Busy. Default is 486 – Busy Here.
Reject Return Code	Specify SIP Code returned for Rejected call. Default is 603 – Decline.
Active URI Limit IP	IP address of the server for the Action URL messages described below.
Push XML Server	IP address for XML server which can send display content to the phone.
Enable Call Waiting Tone	Enables audible notification of call waiting.
Enable Multi Line	Enable phone to make calls for 10 lines max, or disable for 2 lines max.
Enable Auto Switch Line	Enable phone to select an available SIP line as default automatically.
Play Dialing DTMF Tone	Enable dialing DTMF tone played, or disable for dialing DTMF tone played.
Action URL Settings	URL for various actions performed by the phone. These actions are recorded and sent as xml files to the server. Sample format is http://InternalServer/FileName.xml
Block Out Settings	Add or Delete Blocked numbers – Enter the prefix of numbers which should not be dialed by the phone. For example, if 001 is

entered, the phone will not dial any numbers beginning with 001. X and x are wildcards which match single digits. For example, if 4xxx or 4XXX is entered, the phone will not dial any 4 digit numbers beginning with 4. It will dial numbers beginning with 4 which are longer or shorter than 4 digits.

Action URL Settings

Setup Completed	<input type="text"/>
Registration Success	<input type="text"/>
Registration Disabled	<input type="text"/>
Registration Failed	<input type="text"/>
Off Hook	<input type="text"/>
On Hook	<input type="text"/>
Incoming Call	<input type="text"/>
Outgoing Call	<input type="text"/>
Call Established	<input type="text"/>
Call Terminated	<input type="text"/>
DND Enabled	<input type="text"/>
DND Disabled	<input type="text"/>
Always Forward Enabled	<input type="text"/>
Always Forward Disabled	<input type="text"/>
Busy Forward Enabled	<input type="text"/>
Busy Forward Disabled	<input type="text"/>
No Ans. Forward Enabled	<input type="text"/>
No Ans. Forward Disabled	<input type="text"/>
Transfer Call	<input type="text"/>
Blind Transfer Call	<input type="text"/>
Attended Transfer Call	<input type="text"/>

Hold	<input type="text"/>
Resume	<input type="text"/>
Mute	<input type="text"/>
Unmute	<input type="text"/>
Missed Call	<input type="text"/>
IP Changed	<input type="text"/>
Idle To Busy	<input type="text"/>
Busy To Idle	<input type="text"/>

Block Out Settings

Block Out

<input type="text"/>	<input type="button" value="Add"/>	<input type="button" value="v"/>	<input type="button" value="Delete"/>
----------------------	------------------------------------	----------------------------------	---------------------------------------

8.3.4.3 DIAL PLAN

This phone supports 7 dialing modes:

17. Press "#" to Send– Dial the desired number, and press # to send it to the server.
18. Fixed Length – The number will be sent to the server after the specified number of digits are dialed.
19. Time Out – Number will be sent to the server after the specified time.
20. User Defined – Customized rules created by the user.

There is a special feature in the dial plan for the case where the user must dial an access code to get an external line. A digit followed by a “,” will cause secondary dial tone to be generated. For example, assume a rule “9,xxxxxxx” is added. When the user dials 9, the phone will generate secondary dial tone. Then, when 8 digits have been dialed, they will all be sent to the server.

21. Press # to Do Blind Transfer - Press # after entering the target number for the transfer. The phone will transfer the current call to the third party.
22. Blind Transfer on Onhook - Hang up after entering the target number for the transfer. The phone will transfer the current call to the third party.
23. Attended Transfer on Onhook - Hang up after the third party answers. The phone will transfer the current call to the third party.
24. Press DSS key to Do Blind Transfer – after talking, press DSS key, programed to memory key type, to make blind transfer directly.

Basic Settings

- Press "#" to Send
- Dial Fixed Length to Send
- Send after second(s)(3~30)
- Press # to Do Blind Transfer
- Blind Transfer on Onhook
- Attended Transfer on Onhook
- Press DSS Key to Do Blind Transfer

Dial Plan Table

Plans:

Dial Plan Special Characters	
[]	Specifies a range of digits to match. May be a range, a list of ranges separated by commas, or a list of digits.
*	Match any single digit that is dialed.
.	Match any arbitrary number of digits including none.
Tn	A time out period before digits are sent of n seconds in length. n is mandatory and can have a value of 0 to 9 seconds. Tn must be the last 2 characters of a dial plan. If Tn is not specified it is assumed to be T0 by default on all dial plans.

RULE
"[1-8]xxx"
"9xxxxxxx"
"911"
"99T4"
"9911x.T4"

Cause extensions 1000-8999 to be dialed immediately

Cause 8 digit numbers beginning with 9 to be dialed immediately

Cause 911 to be dialed immediately

Cause 99 to be dialed after 4 seconds.

Cause any number beginning with 9911 to be dialed 4 seconds after dialing ceases.

Note: End with “#”, Fixed Length, Time out and Digital Map Table can be used simultaneously.

8.3.4.4 CONTACT

Enter the name, phone number and ring type for each contact here.

AUDIO
FEATURE
DIAL PLAN
CONTACT
REMOTE CONTACT
WEB DIAL
MCAST

Phonebook Table

Group: All [Hangup](#)

Index	Name	Office Number	Mobile Number	Other Number	Ring Type	Group	<input type="checkbox"/>
Page: 1	Pre	Next	friend	Add	Add to Blacklist	Delete	Delete All

Add Contact

Name: Ring Type: Default

Office Number: Line: Auto

Mobile Number: Line: Auto

Other Number: Line: Auto

Group Setting: Unselected | Selected

friend
home
work
business
classmate

Add

→

←

Modify

Clear

Import Contact List

Select File: Browse (*.xml,*.vcf,*.csv) Update

Export Contact List

Export XML Export CSV Export VCF

Group Option

Group: friend

Name:

Ring Type: Default

Add Modify Delete Delete All

Blacklist Settings

Blacklist Item: 1 Delete Delete All

Type: Number

Value: Add

Line: Auto

Blacklist

Field Name	Explanation
Phonebook Tables	
Group	Dropdown box to select group
Name	Contact name
Office Number, Mobile Number, Other Number	Contact phone numbers

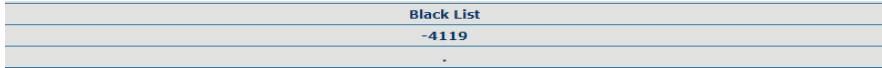
Ring Type	Ring type for this contact
Group	Contact group for this contact
Add Contact	
Name	Contact name
Office Number, Mobile Number, Other Number	Contact phone numbers
Line	Select line for associated contact number
Ring Type	Ring type for this contact
Group Setting	Choose the group or groups for this contact and move them to the Selected list on the right.
Import Contact List	
Select File	Click the browse button to select the phonebook file to import. Then click the update button and the selected file will be added to the phone. File must be xml, vcf or csv format.
Export Contact List	
Export XML	Export contacts to xml file.
Export CSV	Export contacts to csv file.
Export VCF	Export contacts to vcf file.
Group Option	
Group	Lists existing groups
Name	Enter name for new group
Ring Type	Ring type for group
Blacklist Settings	
Type	Select the blacklist type - number or prefix
Value	Input number or prefix
Line	Select the sip line
<p>Note: The maximum capability of the phonebook is 500 contacts.</p> <p>Note: “x” and “.” are special characters in the black list. “x” matches any single digit and “.” matches any number of digits. For example, “4xxx” matches any 4 digit number beginning with 4. “6.” Matches any digit string beginning with 6.</p> <p>Note: There is also an allowed number list feature if the user only wants to allow a limited access to the phone. To use this, precede the number with “-“. For example, -123456, or -1234xx.</p> <p>Allowed number lists must end with an entry which is only a “.”</p>	
	
This will forbid incoming calls from any number except 4119.	

8.3.4.5 R
E
M
O
T
E
C
O
N
T
A
C
T

Allows you access to remote contact lists

either via XML or LDAP.

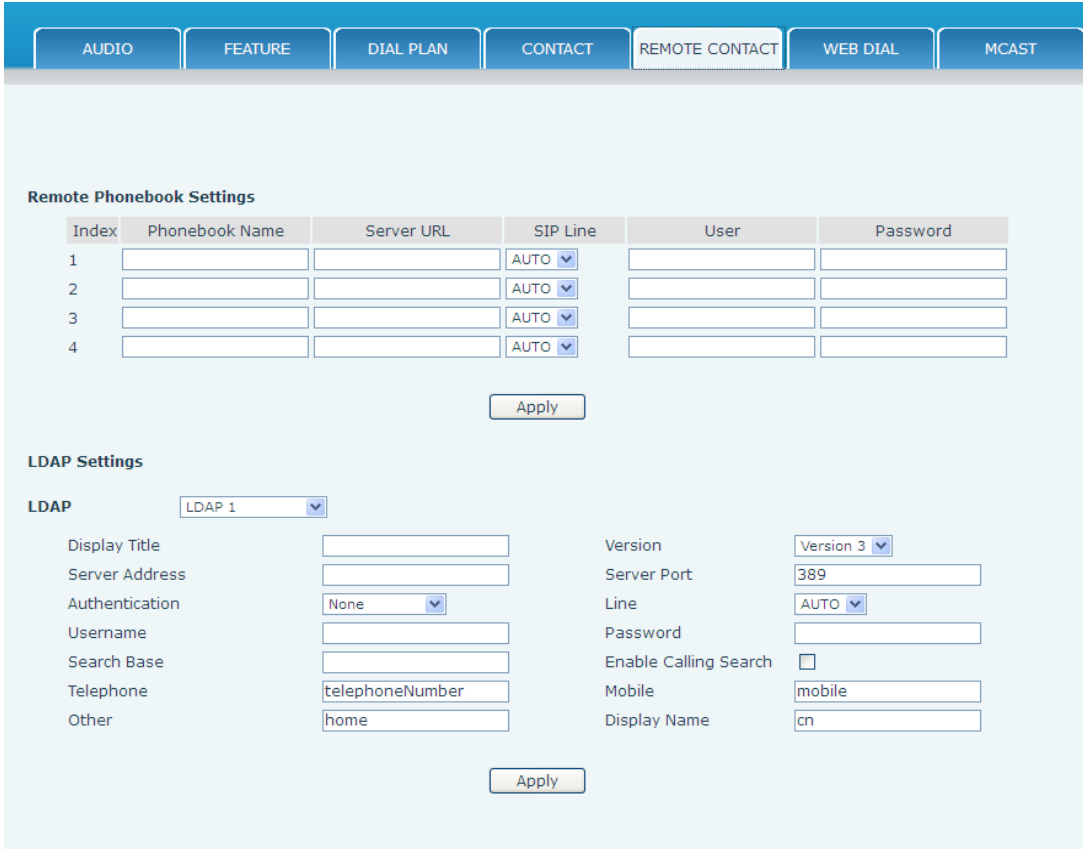

The screenshot shows two configuration sections. The top section, 'Remote Phonebook Settings', contains a table with 6 columns: Index, Phonebook Name, Server URL, SIP Line, User, and Password. There are four rows, each with an 'Apply' button below the table. The bottom section, 'LDAP Settings', includes a dropdown for 'LDAP' (set to 'LDAP 1') and various input fields for 'Display Title', 'Server Address', 'Authentication', 'Username', 'Search Base', 'Telephone', 'Other', 'Version', 'Server Port', 'Line', 'Password', 'Enable Calling Search', 'Mobile', and 'Display Name'. An 'Apply' button is located at the bottom of this section.

TFTP example for remote xml mode: Set the Phonebook Name as Fanvil - Server URL is tftp://192.168.1.3/admin/phonebook/index.xml.

Remote Phonebook Settings	
Phonebook Name	Phonebook name displayed on the phone.
Server URL	Server url of the remote phonebook.
SIP Line	SIP line for the remote phonebook.
User/password	Authentication username and password.

LDAP Settings	
Display Title	The name displayed on the LCD.
Version	LDAP protocol version; supports 3 as default.
Server Address	LDAP server address.
Server Port	LDAP server port.
Authentication	depending on the server's authentication mode. There are

	NONE,DIGEST-MD5,CRAM-MD5,SIMPLE
Line	Assigned SIP line for the LDAP dialing
Username	User name for LDAP authentication
Password	Password for LDAP authentication
Search Base	Search data directory
Enable Calling Search	Allow LDAP contact search and display LDAP contact name during dialing and incoming call.
Telephone	Display LDAP contact's telephone number
Mobile	Display LDAP contact's mobile phone number
Other	Display LDAP contact's other number
Display Name	Allow display LDAP contact name or not

8.3.4.6 WEB DIAL

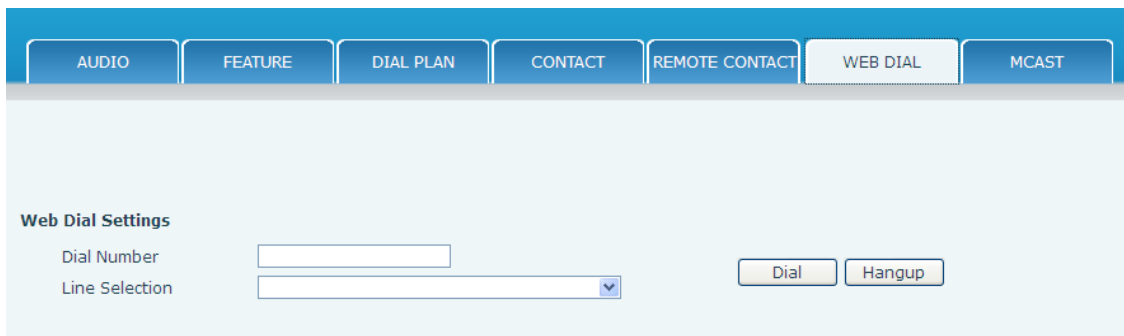

This feature allows a call to be initiated by a computer. To place a call, enter the number in the Dial Number box, select the line in the Line Selection box and press the Dial button. To end the call, press the Hangup button.

8.3.4.7 Multicast

This feature allows you to make some kind of broadcast call to people who are in multicast group. You can configure a multicast key on the phone, which allows you to send a Real Time Transport Protocol (RTP) stream to the pre-configured multicast address(es) without involving SIP signaling. You can also configure the phone to receive an RTP stream from pre-configured multicast listening address(es) without involving SIP signaling. You can specify up to 10 multicast listening addresses.

AUDIO	FEATURE	DIAL PLAN	CONTACT	REMOTE CONTACT	WEB DIAL	MCAST
-------	---------	-----------	---------	----------------	----------	-------

MCAST Settings

Priority

Enable Page Priority

Index/Priority	Name	Host:port
1	<input type="text"/>	<input type="text"/>
2	<input type="text"/>	<input type="text"/>
3	<input type="text"/>	<input type="text"/>
4	<input type="text"/>	<input type="text"/>
5	<input type="text"/>	<input type="text"/>
6	<input type="text"/>	<input type="text"/>
7	<input type="text"/>	<input type="text"/>
8	<input type="text"/>	<input type="text"/>
9	<input type="text"/>	<input type="text"/>
10	<input type="text"/>	<input type="text"/>

MCAST Settings	
Priority	Define the priority of the active call, 1 is the highest priority, 10 is the lowest.
Enable Page Priority	The voice call in progress shall take precedence over all incoming paging calls.
Name	Listened multicast server name
Host:port	Listened multicast server's multicast IP address and port.

8.3.5 Function Key

8.3.5.1 Softkeys

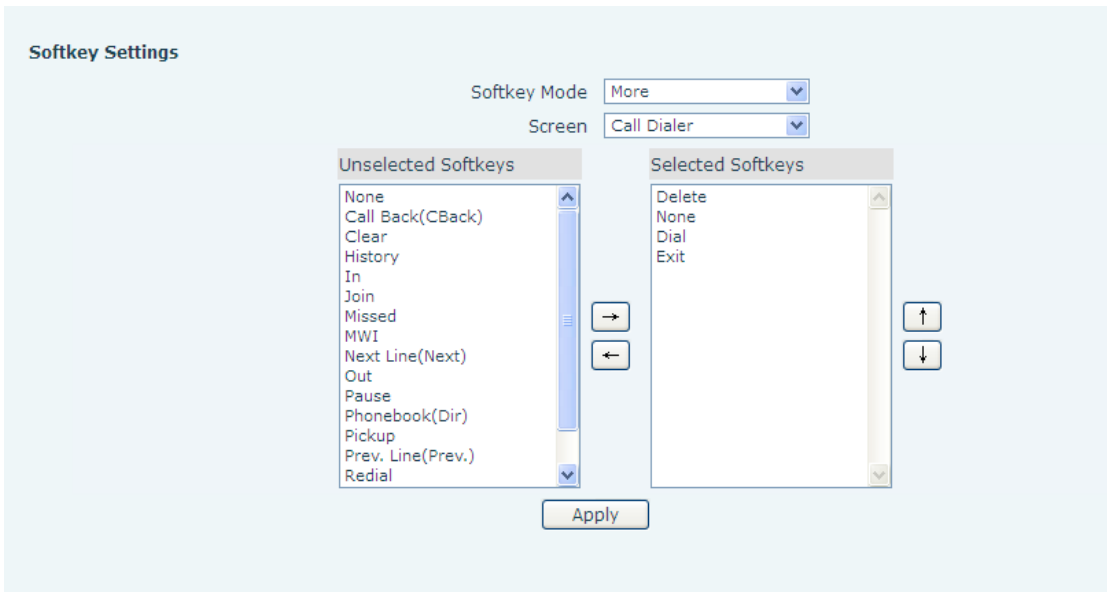

Configure the functions performed by the softkeys under the LCD in various phone operating modes.

8.3.6 Maintenance

8.3.6.1 Auto Provision

The phone supports PnP, DHCP, and Phone Flash to obtain configuration parameters. They will be queried in the following order when the phone boots.

DHCP → PnP server → Phone Flash

AUTO PROVISION	SYSLOG	CONFIG	UPDATE	ACCESS	REBOOT
----------------	--------	--------	--------	--------	--------

Auto Provision Settings

Current Config Version: 2.0002
 Common Config Version: 2.0002
 CPE Serial Number: 00100400XH020010000000010e597052
 User:
 Password:
 Config Encryption Key:
 Common Config Encryption Key:
 Save Auto Provision Information:

DHCP Option Settings >>

Plug and Play (PnP) Settings >>

Phone Flash Settings >>

TR069 Settings >>

DHCP Option Settings >>

DHCP Option Setting:
 Custom DHCP Option: (128~254)

Plug and Play (PnP) Settings >>

Enable PnP:
 PnP Server:
 PnP Port:
 PnP Transport:
 PnP Interval: hour(s)

Phone Flash Settings >>

Server Address:
 Config File Name:
 Protocol Type:
 Update Interval: hour(s)
 Update Mode:

TR069 Settings >>

Enable TR069
 ACS Server Type
 ACS Server URL
 ACS User
 ACS Password
 TR069 Auto Login
 "Inform" Sending Period second(s)

Auto Provision Settings	
Field Name	Explanation
Current Config Version	Show the current config file's version. If the version of configuration downloaded is higher than this, the configuration will be upgraded. If the endpoints confirm the configuration by the Digest method, the configuration will not be upgraded unless it differs from the current configuration.
Common Config Version	Show the common config file's version. If the configuration downloaded and this configuration are the same, the auto provision will stop. If the endpoints confirm the configuration by the Digest method, the configuration will not be upgraded unless it differs from the current configuration.
CPE Serial Number	Serial number of the phone
User	Username for configuration server. Used for FTP/HTTP/HTTPS. If this is blank the phone will use anonymous.
Password	Password for configuration server. Used for FTP/HTTP/HTTPS.
Config Encryption Key	Encryption key for the configuration file
Common Config Encryption Key	Encryption key for common configuration file
Save Auto provision Information	Save the Autoprovision username and password in the phone until the server url changes

DHCP Option Settings >>

DHCP Option Setting
 Custom DHCP Option (128~254)

DHCP Option Settings	
Field Name	Explanation
DHCP Option Setting	The phone supports configuration from Option 43, Option 66, or a Custom DHCP option. It may also be disabled.
Custom DHCP Option	Custom option number. Must be from 128 to 254.

Plug and Play (PnP) Settings >>

Enable PnP
 PnP Server
 PnP Port
 PnP Transport
 PnP Interval hour(s)

Plug and Play(pnp) Settings	
Enable PnP	If this is enabled, the phone will send SIP SUBSCRIBE messages to a multicast address when it boots up. Any SIP server understanding that message will reply with a SIP NOTIFY message containing the Auto Provisioning Server URL where the phones can request their configuration.
PnP Server	PnP Server Address
PnP Port	PnP Server Port
PnP Transport	PnP Transfer protocol – UDP or TCP
PnP Interval	Interval time for querying PnP server. Default is 1 hour.

Phone Flash Settings >>

Server Address
 Config File Name
 Protocol Type
 Update Interval hour(s)
 Update Mode

Phone Flash Settings	
Server Address	Set FTP/TFTP/HTTP server IP address for auto update. The address can be an IP address or Domain name with subdirectory.
Protocol Type	Specify the Protocol type FTP, TFTP or HTTP.
Config File Name	Specify configuration file name. The phone will use its MAC ID as the config file name if this is blank.
Update Interval	Specify the update interval time. Default is 1 hour.
Update Mode	1. Disable – no update

- | | |
|--|---|
| | 2. Update after reboot – update only after reboot.
3. Update at time interval – update at periodic update interval |
|--|---|

TR069 Settings >>

Enable TR069

ACS Server Type

ACS Server URL

ACS User

ACS Password

TR069 Auto Login

"Inform" Sending Period second(s)

TR069 Settings	
Enable TR069	Enable/Disable TR069 configuration
ACS Server Type	Select Common or CTC ACS Server Type.
ACS Server URL	ACS Server URL.
ACS User	User name for ACS.
ACS Password	ACS Password.
TR069 Auto Login	Enable/Disable TR069 Auto Login.
"Inform" Sending Period	Time between transmissions of "Inform" Unit is seconds.

8.3.6.2 Syslog

Syslog is a protocol used to record log messages using a client/server mechanism. The Syslog server receives the messages from clients, and classifies them based on priority and type. Then these messages will be written into a log by rules which the administrator has configured. There are 8 levels of debug information.

Level	Name	Description
0	Emergency	System is unusable. This is the highest debug info level.
1	Alert	Action must be taken immediately.
2	Critical	Critical conditions. System is probably working incorrectly.
3	Error	Error conditions. System may not work correctly.
4	Warning	Warning conditions. System may work correctly but needs attention.
5	Notice	Normal but significant condition.
6	Informational	Normal daily messages.
7	Debug	Debug messages normally used by system designer. This level

	can only be displayed via telnet.
--	-----------------------------------

AUTO PROVISION	SYSLOG	CONFIG	UPDATE	ACCESS	REBOOT
----------------	--------	--------	--------	--------	--------

Syslog Settings

Server Address

Server Port

MGR Log Level

SIP Log Level

IAX2 Log Level

Enable Syslog

Watch Dog

Enable Watch Dog

Web Capture

Syslog Configuration	
Field Name	Explanation
Syslog Settings	
Server IP	Syslog server IP address.
Server Port	Syslog server port.
MGR Log Level	Set the level of MGR log.
SIP Log Level	Set the level of SIP log.
IAX2 Log Level	Set the level of IAX2 log.
Enable Syslog	Enable or disable syslog.
Watch Dog	
Enable watch Dog	Enable watchdog phone die chance to automatically restart, disable watchdog does not
Web Capture	
Start	Capture a packet stream from the phone. This is normally used to troubleshoot problems.
Stop	Stop capturing the packet stream

8.3.6.3 Config Setting

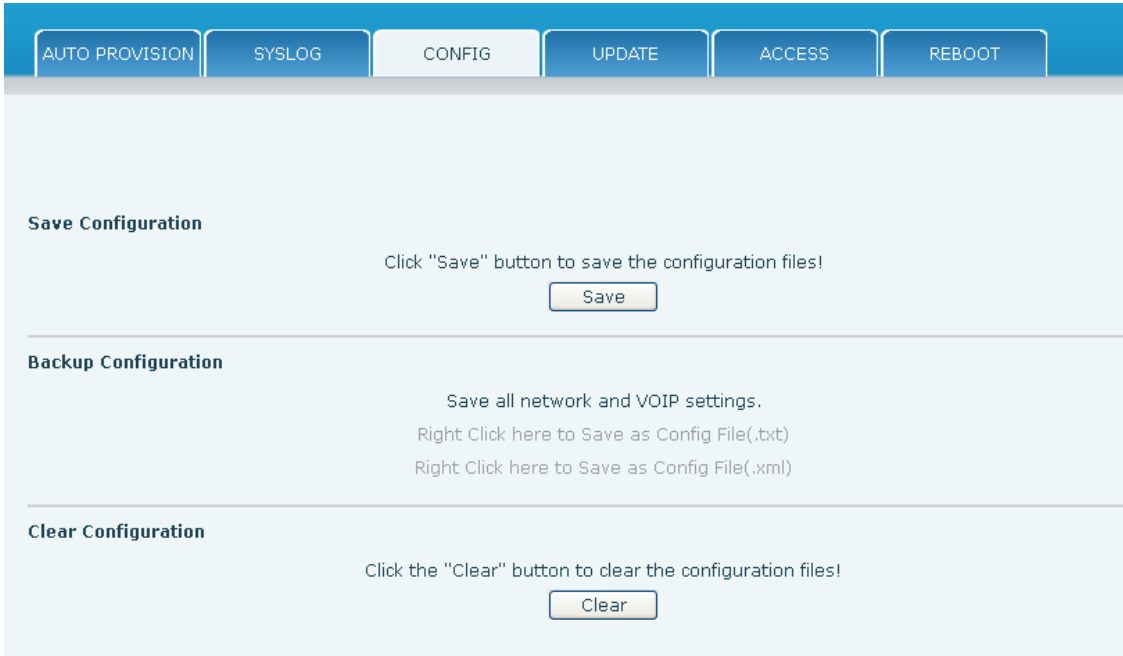

Config Setting	
Field Name	Explanation
Save Configuration	Save the current phone configuration. Clicking this saves all configuration changes and makes them effective immediately.
Backup Configuration	Save the phone configuration to a txt or xml file. Please note to Right click on the choice and then choose "Save Link As."
Clear Configuration	Logged in as Admin, this will restore factory default and remove all configuration information. Logged in as Guest, this will reset all configuration information except for VoIP accounts (SIP1-2 and IAX2) and version number.

8.3.6.4 Update

This page allows uploading configuration files to the phone.

Update	
Field Name	Explanation
Web Update	
Web Update	Browse to the config file, and press Update to load it to the phone. Various types of files can be loaded here including firmware, ring tones, local phonebook and config files in either text or xml format.
TFTP/FTP Update	
Server Address	FTP/TFTP server address for download/upload. The address can be IP address or Domain name with subdirectory.
User	FTP server Username for download/upload.
Password	FTP server password for download/upload.

File name	Name of update file or config file. The default name is the MAC of the phone.
<p>Note: The exported config file can be modified. The config file is made up of modules. Modules which do not need changes may be deleted. For example, a config file can be downloaded and all modules removed except the SIP module. After rebooting, only the SIP settings will be changed.</p>	
Type	<p>Action to be executed by the phone.</p> <ol style="list-style-type: none"> 1. Application update - download system update file 2. Config file export - Upload config file to FTP/TFTP server. It can then be named and saved. 3. Config file import - Download the config file from FTP/TFTP server. The configuration will be effective after the phone is reset. 4. Phone book export (.vcf, .csv, .xml) - Upload the phonebook file to FTP/TFTP server. It can then be named and saved. 5. PhoneBook import (.vcf, .csv, .xml) - Download phonebook file from FTP/TFTP server.
Protocol	Select FTP/TFTP server.
Update Logo File	
Select File	URL of the logo file.
Delete Logo File	
Select File	Logo file name to be deleted.
Logo File	
Logo File	Logo file in use.

8.3.6.5 Access

User accounts can be added or deleted from this page. The authority of accounts can also be changed.

Access Configuration	
Field Name	Explanation
LCD Menu Password Settings	
Menu Password	Sets the password for entering the setup menu from the phone keypad. The password must be only digits.
Keyboard Lock Settings	
Quick lock key code	Direct press set passwords can lock the keyboard
The key password	Set phone keyboard lock password, must enter Numbers, limit is no more than 6 characters

Open the keyboard lock	Set whether to open the keyboard lock, default to cancel
User Settings	
This table shows the current user accounts	
Add User	
User	Set User Account name
User Level	There are two levels. Root user can modify the configuration. General user can only read the configuration.
Password	Set the password
Confirm	Confirm the password
User Management	
Select the account and click Modify to modify the selected account. Click Delete to delete the selected account. A General user can only add another General user.	

8.3.6.6 Reboot

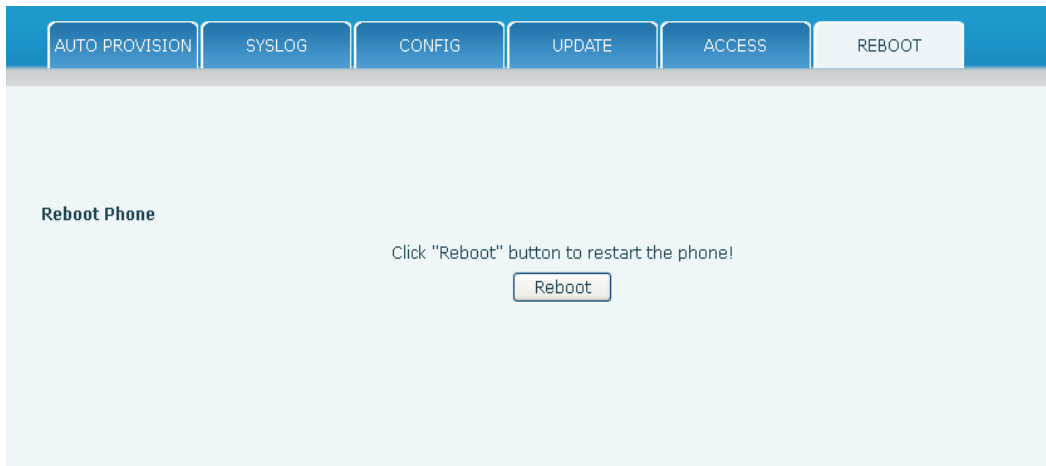

Some configuration modifications require a reboot to become effective. Clicking the Reboot button will cause the phone to reboot immediately.

Note: Be sure to save the configuration before rebooting.

8.3.7 Security

8.3.7.1 WEB FILTER

WEB Filter	
The Web filter is used to limit access to the phone. When the web filter is enabled, only the IP addresses between the start IP and end IP can access the phone.	
Field Name	Explanation
Start IP Address	Beginning IP Address for MMI Filter
End IP Address	Ending IP Address for MMI Filter
Add	Add this filter range to the Web Filter Table
Enable Web Filter	Select to enable MMI Filter.
Apply	Make filter settings effective.
Note: Once a range is added, it can be modified or deleted.	
Note: Be sure that the filter range includes the IP address of the configuration computer.	

8.3.7.2 Firewall

WEB FILTER
FIREWALL
NAT
VPN
SECURITY

Firewall Type

Enable Input Rules Enable Output Rules

Firewall Input Rule Table

Index	Deny/Permit	Protocol	Src Address	Src Mask	Dest Address	Dest Mask	Range	Port

Firewall Output Rule Table

Index	Deny/Permit	Protocol	Src Address	Src Mask	Dest Address	Dest Mask	Range	Port

Firewall Settings

Input/Output	<input type="button" value="Input"/>	Src Address	<input type="text"/>	<input type="button" value="Add"/>
Deny/Permit	<input type="button" value="Deny"/>	Dest Address	<input type="text"/>	
Protocol	<input type="button" value="UDP"/>	Src Mask	<input type="text"/>	
Port Range	<input type="button" value="more than"/> <input type="text"/>	Dest Mask	<input type="text"/>	

Rule Delete Option

Input/Output	<input type="button" value="Input"/>	Index To Be Deleted	<input type="text"/>	<input type="button" value="Delete"/>
--------------	--------------------------------------	---------------------	----------------------	---------------------------------------

Firewall Configuration

Firewall rules can be used to prevent unauthorized Internet users from accessing private networks connected to this phone (input rule), or prevent unauthorized devices connected to this phone from accessing the Internet (output rule). Each rule type supports a maximum of 10 items.

Field Name	Explanation
Enable Input Rules	Enable rules limiting access from the Internet.
Enable Output Rules	Enable rules limiting access to the Internet.
Input/Output	Specify if the current rule is input or output.
Deny/Permit	Specify if the current rule is Deny or Permit.
Protocol	Filter protocol type (TCP/ UDP/ ICMP/ IP)
Port Range	Set the filter Port range
Src Address	Set source address. It can be a single IP address or use * as a wild card. For example: 192.168.1.14 or *.*.*.14.

Dest Address	Set destination address. It can be a single IP address or use * as a wild card. For example: 192.168.1.14 or *.*.*.14.																											
Src Mask	Set the source address mask. For example: 255.255.255.255 points to one host while 255.255.255.0 points to a C type network.																											
Dest Mask	Set the destination address mask. For example: 255.255.255.255 points to one host while 255.255.255.0 points to a C type network.																											
<table border="1"> <thead> <tr> <th colspan="9">Firewall Input Rule Table</th> </tr> <tr> <th>Index</th> <th>Deny/Permit</th> <th>Protocol</th> <th>Src Address</th> <th>Src Mask</th> <th>Dest Address</th> <th>Dest Mask</th> <th>Range</th> <th>Port</th> </tr> </thead> <tbody> <tr> <td>1</td> <td>Deny</td> <td>UDP</td> <td>192.168.1.14</td> <td>255.255.255.0</td> <td>192.168.1.118</td> <td>255.255.255.0</td> <td>More than</td> <td>1</td> </tr> </tbody> </table>		Firewall Input Rule Table									Index	Deny/Permit	Protocol	Src Address	Src Mask	Dest Address	Dest Mask	Range	Port	1	Deny	UDP	192.168.1.14	255.255.255.0	192.168.1.118	255.255.255.0	More than	1
Firewall Input Rule Table																												
Index	Deny/Permit	Protocol	Src Address	Src Mask	Dest Address	Dest Mask	Range	Port																				
1	Deny	UDP	192.168.1.14	255.255.255.0	192.168.1.118	255.255.255.0	More than	1																				
When a connected device tries to access 192.168.1.118, the phone will deny the request because of the out_access rule. Access to any other IP address will be allowed.																												
Click the Delete button to delete the selected rule.																												

8.3.7.3 Network Address Translation (NAT)

NAT is the process of modifying IP address and port information in transition from a private to a public network. NAT allows the use of one public address to support many private addresses.

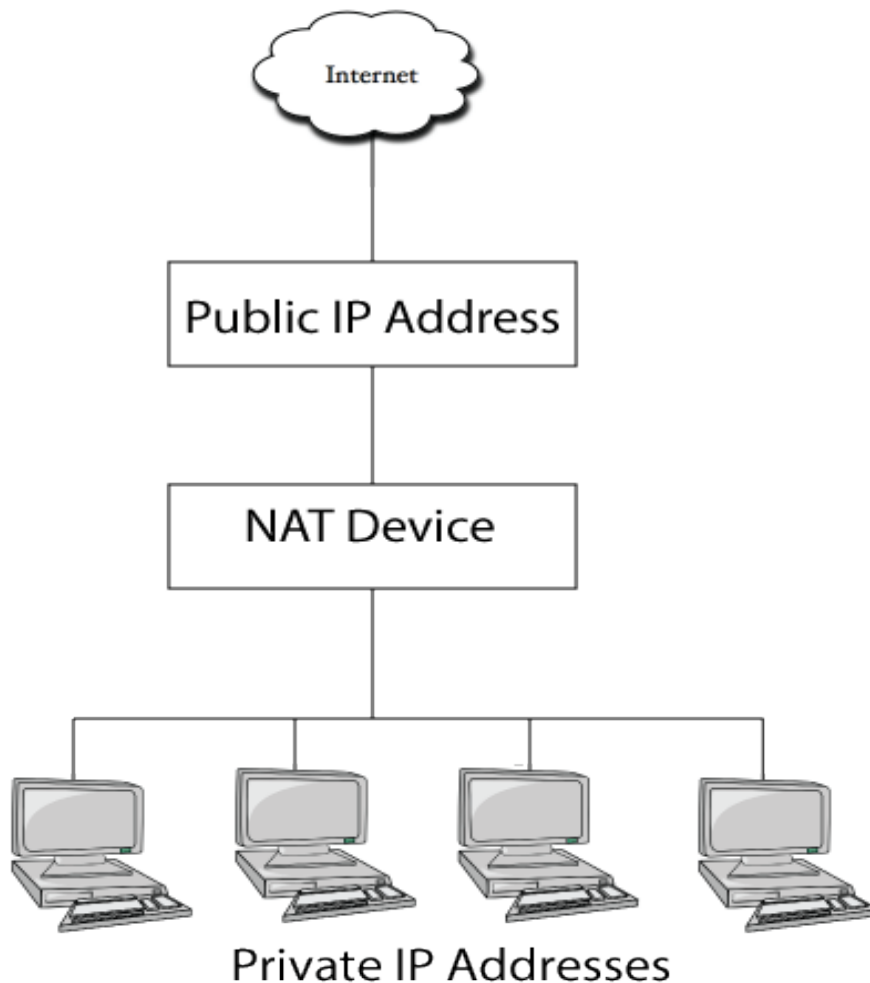

DMZ Configuration

Servers in a network most vulnerable to attack are those which provide services to users outside the local network. Many times these computers are placed into their own sub-network to provide more protection to the rest of the local network. This sub-network is called a DMZ (taken from “demilitarized zone”). Computers in the DMZ have limited connectivity to specific hosts in the internal network, although communication with other hosts in the DMZ and to the external network is allowed. This allows hosts in the DMZ to provide services to both the internal and external network, while a firewall controls the traffic between the DMZ servers and the internal network clients.

The following chart describes the network access control of DMZ.

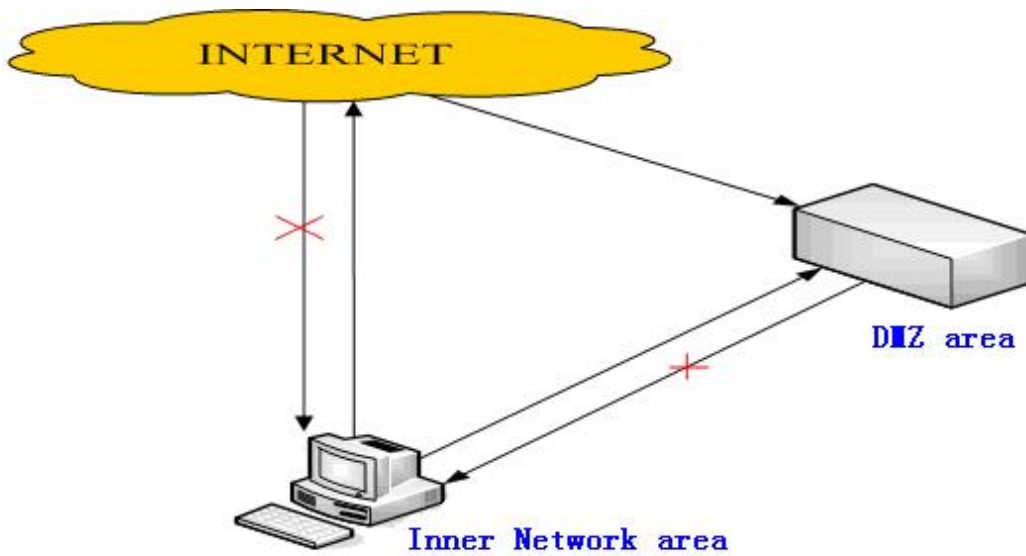

WEB FILTER
FIREWALL
NAT
VPN
SECURITY

Application Layer Gateway (ALG) Settings

IPSec ALG FTP ALG PPTP ALG

Network Address Translation (NAT) Table

Inside IP Address	Inside TCP Port	Outside TCP Port
Inside IP Address	Inside UDP Port	Outside UDP Port

NAT Table Option

Transfer Type: Outside Port:

Inside IP Address: Inside Port:

Application Layer Gateway (ALG) Settings	
Field Name	Explanation

IPSec ALG	Enable/Disable IPSec encryption. Default is enabled.
FTP ALG	Allow the ALG to securely pass FTP traffic. Default is enabled.
PPTP ALG	Allow the ALG to securely pass PPTP traffic. Default is enabled.
Network Address Translation (NAT) Table	
Shows the NAT TCP and UDP mapping tables	
NAT Table Option	
Transfer Type	Select the TCP or UDP protocol.
Inside IP	Set the local IP address of device.
Inside Port	Set the LAN (inside) port for NAT mapping
Outside Port	Set the WAN (outside) port for NAT mapping
Note: After entering settings, click the Add button to add new mapping table data. To delete an entry, enter its information and then click the Delete button.	
Notice: The phone supports 10M/100M adaptive. Under loaded conditions traffic through the phone NAT may not reach 100M.	

8.3.7.4 VPN

The phone supports remote connection via VPN. It supports both Layer 2 Tunneling Protocol (L2TP) and OpenVPN protocol. This allows users at remote locations on the public network to make secure connections to local networks.

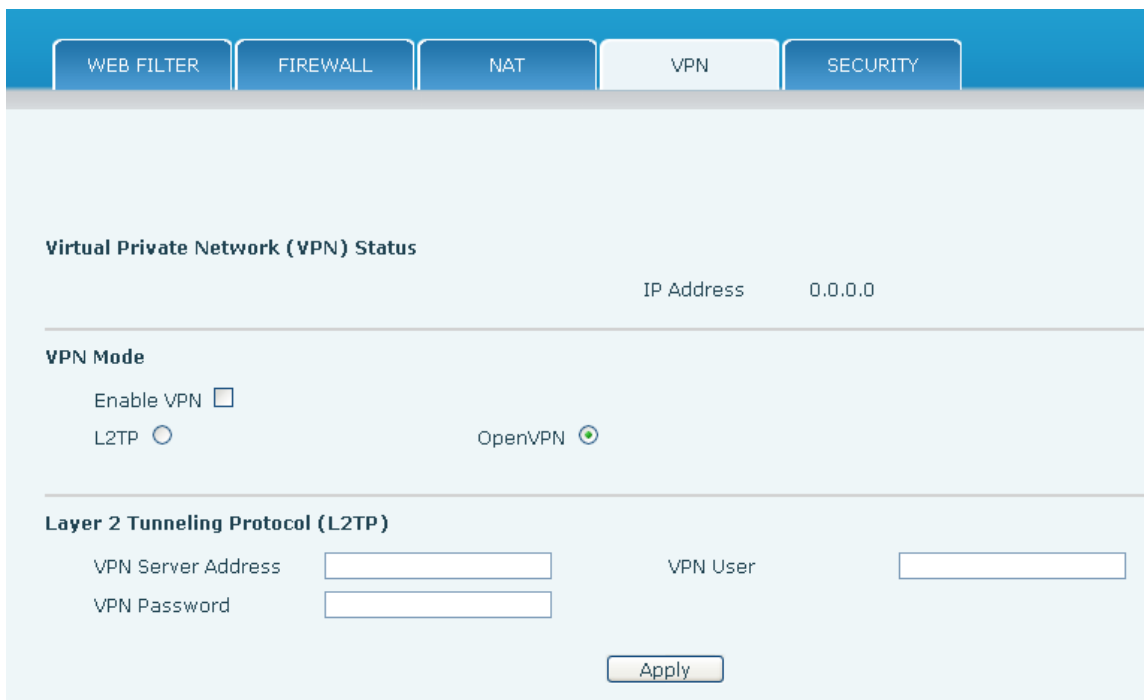

The screenshot shows the VPN configuration page with the following sections:

- Navigation:** WEB FILTER, FIREWALL, NAT, VPN (selected), SECURITY
- Virtual Private Network (VPN) Status:** IP Address: 0.0.0.0
- VPN Mode:**
 - Enable VPN:
 - L2TP:
 - OpenVPN:
- Layer 2 Tunneling Protocol (L2TP):**
 - VPN Server Address:
 - VPN Password:
 - VPN User:
- Buttons:** Apply

Field Name	Explanation
VPN Status	Shows the current VPN IP address.
VPN Mode	
Select L2TP. You can choose only one for current state. After you select it, save the configuration and reboot the phone.	
Enable VPN	Enable/Disable VPN.
L2TP	Select Layer 2 Tunneling Protocol
OpenVPN	Select OpenVPN Protocol
Only one protocol may be activated. After the selection is made, the configuration should be saved and the phone rebooted.	
VPN Server Address	Set VPN L2TP Server IP address.
VPN User	Set User Name access to VPN L2TP Server.
VPN Password	Set Password access to VPN L2TP Server.

8.3.7.5 Security

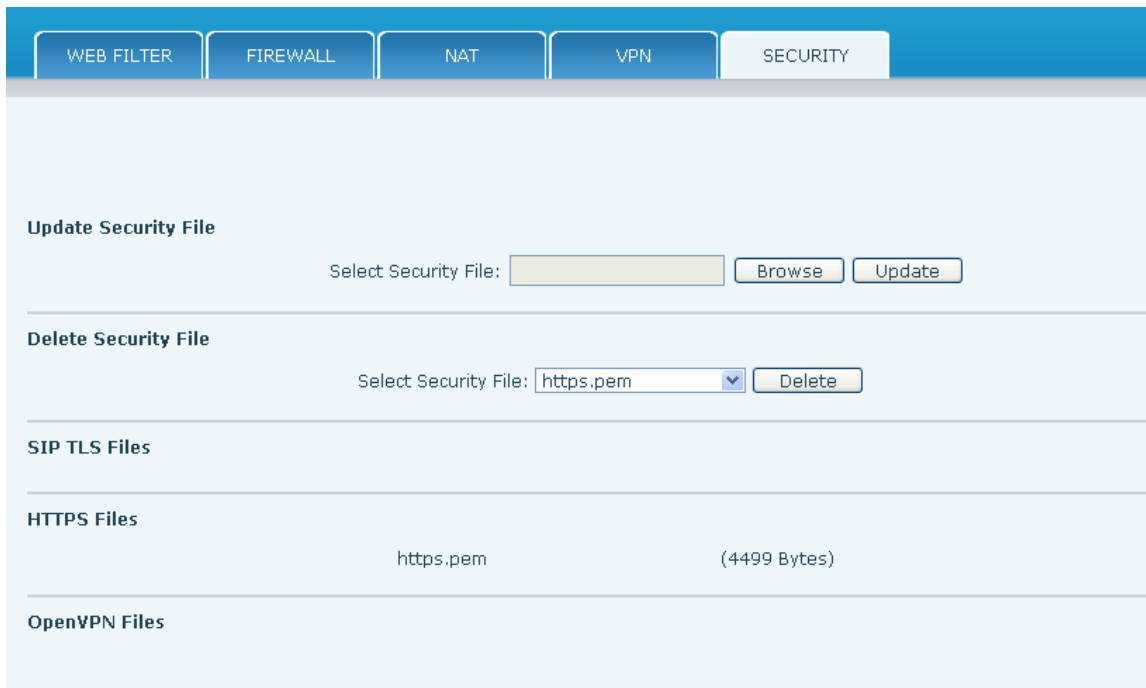

Field Name	Explanation
Update Security File	
Select Security File	Browse to the security file to be updated. Click the Update button to update.

Delete Security File	
Select Security File	Select the security file to be deleted. Click the Delete button to Delete.
SIP TLS File	Show SIP TLS authentication certificate.
HTTPS File	Show HTTPS authentication certificate.
OpenVPN Files	Show OpenVPN File authentication certificate file.

8.3.8 Logout

Logout

Click "Logout" button to logout the system!

9 Click Logout to exit the phone web page.

Appendix

9.1 Specification

9.1.1 Hardware

Item		Specification
Power Adapter		Input: 100-240V
		Output: 5V 1A
Port	WAN	10/100Base-T RJ-45 1 PORT
	LAN	10/100Base-T RJ-45 1 PORT
Power Consumption		Idle: 2.5W
		Active: 2.8W
LCD Size		128x48 pixels
Operation Temperature		0~40°C
Relative Humidity		10~65%
CPU		Broadcom
SDRAM		16MB
Flash		4MB

Dimension(L x W x H)	250×205×60mm
Weight	0.84kg

9.1.2 Voice Features

- Supports 2 SIP servers
- Supports RFC3261
- Codecs
 - G.711A/U
 - G.723.1 high/low
 - G.729A/B
 - G.722
 - G.726
 - Codec Setting per SIP line
- Echo cancellation: G.168 Compliance in LEC, additional acoustic echo cancellation(AEC) can reach 96ms max filter length in hands-free mode
- Supports Voice Gain Setting, VAD, CNG
- Full duplex hands-free
- Multi line
- HD Voice
- SIP support
 - SIP domain
 - SIP authentication
 - none
 - basic
 - MD5
- DNS
- Peer to Peer/ IP call
- Automatic line selection
- 9 Standard ring tones and 3 user-defined ring tones
- DTMF
 - SIP info
 - DTMF In-Band
 - RFC2833
 - AUTO
- SIP applications
 - Call Forward
 - Call Transfer (Blind/Attended)

- Hold
- Call Waiting
- 3 Way Conference
- SMS
- Remote Pickup
- Join Call
- Redial
- Unredial
- Multi-line
- Intercom
- Push to talk
- Auto Redial
- Call Back
- Call control features
 - Flexible dial plan
 - Hotline
 - Anonymous Call Reject
 - Black List (Reject Authenticated Call)
 - Limit Call
 - Do Not Disturb
 - Caller ID
 - CLIR (reject anonymous call)
 - CLIP(make anonymous call)
 - Dial without Registration
- Phonebook 500 records
- Support call logs
 - Incoming Calls
 - Outgoing Calls
 - Missed Calls
 - Max of 300 Records Each
 - Supports vCard/XML/CSV
- Support IAX2
- Programmable Soft Keys
- Code synchronization
 - IP PBX
 - IMS
- Supports Click to Dial via Web Phone Book
- Keypad Lock with Emergency Call

- Customized LCD logo as screensaver
- Ring Tone via Speaker
- Customized Signal Tone Parameters
- Time Display
 - 12/24 Hour
 - Support Daylight Saving Time
- Supports Path, Group
- Supports SIP Privacy
- Supports MWI
- Supports Speed Dial
- Supports XML













9.1.3 Network Features

- WAN/LAN
 - Bridge
 - Bridge with port mirror
 - Router
- Supports PPPoE for xDSL
- Supports Basic NAT and NAPT
- Supports VLAN
 - 802.1Q
 - 802.1P
- Supports STUN
- Supports DMZ
- Supports VPN
 - L2TP
 - OpenVPN
- Wan Port Supports Main DNS and Secondary DNS
- Supports DNS via DHCP or Static DNS
- Supports DHCP client on WAN
- Supports DHCP server on LAN
- QoS with DiffServ
- Network Tools in Telnet Server
 - Ping
 - Trace Route
 - Telnet Client

9.1.4 Maintenance and management

- Firmware Upgrade
 - POST
 - HTTP
 - FTP
 - TFTP
 - HTTPS
- Configuration
 - Web
 - Telnet
 - Phone Keypad
- Two Account Levels
- Multi-Language Support
 - English
 - Chinese
- Supports Syslog
- Supports Auto Provisioning
 - Firmware Upgrade
 - Auto-Provisioning

9.2 Digit-character map table

Keypad	Character	Keypad	Character
	1 @		7 P Q R S p q r s
	2 A B C a b c		8 T U V t u v
	3 D E F d e f		9 W X Y Z w x y z
	4 G H I g h i		*./
	5 J K L j k l		0
	6 M N O m n o		#/=